

# MATHS WISE



# TABLE OF CONTENTS

▶	<b>Introduction</b>		<b>v</b>
▶	<b>Unit 1</b>	<b>Review and Assess 1</b>	<b>2</b>
		Unit Objectives: To reinforce lessons learnt in previous year Skills learnt: Students will re-learn some of the concepts that were taught in Class 1. This will encourage recall skills and help with more advanced concepts to be taught in class 2	
▶	<b>Unit 2</b>	<b>Numbers</b>	<b>4</b>
		Unit Objectives: To introduce ordinal numbers and place values of numbers; write number names; learn ascending/descending numbers; teach greater than/less than and equality symbols; introduction of fractions; how to read and write fractions and learn to fraction a group from a bigger set Skills learnt: Students will learn to recognize ordinal numbers and read and write them; they will learn to write number names from 1–50; they will learn to group in tens and then learn place value of numbers; they will learn ascending/descending orders; they should demonstrate understanding of equal to (=), greater than (>) and less than (<) symbols; they will know what fractions are and learn to read and write them, study examples of simple fraction problems and learn to recognize fractions in real-life objects	
▶	<b>Unit 3</b>	<b>Number Operations</b>	<b>14</b>
		Unit Objectives: To learn to add/subtract two-and three-digit numbers according to place value; learn basic multiplication; learn the order property in multiplication; learn times tables up to 5 and times table of 10; learn basic division Skills learnt: Students will learn to do two-and three-digit addition and subtraction using the concept of place value learnt in the previous chapter; they will learn to do simple multiplication and division with the help of the times tables; they will learn to solve word problems using all number operations	
	<b>Unit 4</b>	<b>Measurement: Length, Weight, and Capacity</b>	<b>27</b>
		Unit Objectives: To learn to use length, weight units and introduce capacity and its units; solve simple sums and word problems involving these measures Skills learnt: Students learn to use units of length, weight, and capacity; they will learn to measure real-life objects, and the instruments used for such measurements; they will be able to clearly compare weights, lengths, and capacities of two different objects; they should be able to solve word problems involving these concepts	



# TABLE OF CONTENTS

▶	<b>Unit 5</b>	<b>Time and Date</b> Unit Objectives: To introduce reading time from the clock; to know what half-hour and quarter of an hour means; know the time taken to complete routine activities; know a.m./p.m. times; to introduce reading dates from the calendar; to introduce lunar and solar calendars Skills learnt: Students learn to read different times on the clock; they should be able to time their activities and differentiate a.m./p.m. times; they will know the difference between the lunar and solar calendars, learn to read dates, and be able to name lunar year months	32
▶	<b>Unit 6</b>	<b>Geometry</b> Unit Objectives: To introduce 2D shapes; do activities to make squares, rectangles, triangles and circles; learn terms such as sides, vertices, quadrants, and semi-circles; to differentiate between a line and a curve; how to use a ruler to draw straight lines; learn about vertical, horizontal and oblique lines; solve simple problems involving measurements Skills learnt: Students learn to recognize 2D shapes; they do interesting activities to make 2D shapes; they must know the different terms associated with shapes; they will learn to draw lines and know their different forms	37
▶	<b>Unit 7</b>	<b>Review and Assess</b> Unit Objectives: Review, reinforcement, and assessment of Units 1–6 Skills learnt: Students should demonstrate understanding and application of concepts learnt in Units 1–6	40
▶	<b>Worksheets</b>		42
▶	<b>Answers to Exercises</b>		64

# INTRODUCTION

## A. Introduction

Children come into Class 2 after having gone through the friendly, happy, and fun atmosphere of class 1 with bright inquisitive minds: playful, but ready to learn more. Remember, learning flourishes in a warm and friendly atmosphere.

The next classes will have a similar cheerful and friendly ambience and with teaching equipment that the children are already familiar with. The books also are an extension of the *Maths Wise* Introductory books. This will make the children feel comfortable and happy, which is very helpful for absorbing and learning new concepts.

The pattern of Teaching in Guide 1 continues. In fact, it is very strongly recommended that teachers of 2 should go through the Introductory books well as Book 1 and their guide.

All work in the books is preceded by a chat session, a classroom demonstration and work on the board, a visit to a garden, a zoo, a vegetable market or a bank, relevant to the topic of the day. The children then work in their books, followed by worksheets related to the topic for reinforcement.

Each lesson needs to be planned; not only the concept but the outdoor visit and the work in the book as well must all have a focus. For example, a visit to the zoo does not mean looking at all 200 animals. The exercises may involve 'guessing' the height of a giraffe (compared to the child's height—3 times or 4 times), measuring the length and breadth of the cages, with paces converted into metres, as the child may have measured his classroom earlier; guessing the amount of food each animal eats, on an average day. With the help of the zoo warden, children discuss the weight of a cub compared with that of a lion, a human baby, or a human adult.

The zoo warden will be happy to give answers, if he is provided with a question sheet in advance.

A Maths Lab becomes more significant as children grow older. Working with their hands and using more than one or two senses makes their memory more retentive.

## B. Maths Laboratory

At the Primary level, a central maths lab with this equipment would be very useful.

- plastic (or wooden) baskets or trays to keep this assortment of items
- bowls of multicoloured beads which can be used for sorting, grouping, and many assorted activities
- some soft-drink bottle caps, strings of 10 bottle caps strung together, and a group of 10 strings knotted together to represent one hundred. Sets of such strings can be used for explaining numbers and concepts of addition and subtraction



- weighing scales of four different types: spring weighing scale, an ordinary balance, a regular scale with a vertical circular dial, and a ground level weighing scale on which children can stand and weigh themselves. Of course, it is fun to show the children weighing scales at the airport and on railway platforms
- tape measures and rulers of different sizes
- shells, beads, and beans (of different sizes) in groups of 10s, 100s, and 1000s, wrapped securely in cloth bags
- several sets of four almost identical objects, one with a very slight difference, can be used to improve the students' powers of observation. For example, four face masks, three identical and one with an extra bunch of hair
- colourful pictures or charts of shops displaying fruits and vegetables and toys, (made in the classroom, to fit the requirement of the class) and a rack of clothes—with price tags
- fabrics or strong paper, to make a simple set of weighing scales
- wooden objects, such as balls (spheres), egg-shapes, dice shapes (cubes), box shapes (cuboids), and cones, set in a tray or in a box
- hollow cubes, cuboids, cylinders, and cones made from thick card, which can be opened out and laid flat
- flat shapes cut out from thick card or wood, such as circles, squares, polygons, and triangles so that the children can feel the flat surface and can count the corners and the edges. It will be useful to have flat shapes which are equal to the size of the solids so that children can find the relationship between, for example, a cube and a square
- rolls of cords and ribbons
- simple Suduko puzzles
- plastic or steel tins, jars, and bowls of different sizes for comparing capacity, placed in a large basket. (It is extremely desirable that bowls made of halves of dried coconut shells or bamboo segments, split in half, are also used where available.)
- pencils and crayons of different colours and lengths
- charts corresponding to every different concept in the book
- stand-alone mirrors, or squares of reflecting surfaces, preferably extra-glossy plastics for viewing symmetry
- a giant number square showing 1 to 100 on the walls and several sheets with blank squares for children to work on
- toy clocks, both analogue and digital, with time cards
- 12 pages (to make up a calendar) with large numbers and the names of the days. Sunshine, rain, and cold weather to be depicted by symbols on each day. Reinforce counting, association of weather with appropriate symbols and clothes which people wear. Seasonal foods can also be a part of the lesson
- geo board (11 x 11)

- links (multicoloured in the shape of gem clips): these help in sequencing and patterns and comparing lengths. These also help in fine motor control, when the child discovers the best way to open clips and join them together
- pegboard with pegs
- magnetic board with letters and numerals
- slates and chalks

Attractive, bright wallcharts and other child-friendly displays on walls go a long way towards making all basic concepts of learning maths very stimulating and exciting for the children.

A soft board covered with chamois and duster cloth is useful, as children can stick numbers or pictures on them and take them off when necessary.

### **C. Maths Wise Book 2**

Book 2 has been written keeping in mind the Pakistan National Curriculum 2006.

The formatting of the book fairly similar to the Introductory Books 1, 2, and 3 and the 'discussion and demonstration' method continues. The pages are pleasing and colourful with child-friendly language and content which makes learning easy and fun. Children continue to be active participants, ask many questions, and learn at their own pace without any pressure to compete with others.

### **D. Topics covered**

Concepts learnt in the pre-primary years and class 1 at school need to be revised and formalized, with the help of some suggestions laid out in the Teaching Guide 2, so advanced knowledge of concepts now forms the core of the primary books. This Guide will deal with Book 2 unit-wise.

A great deal of classroom work from the books as well as on extra sheets or in class notebooks is necessary for the children to be able to work out exercises given in the book or solve problems mentally.

#### **1. Activities**

Activities in Class 2 will further help in:

1. concentration, because they create interest in the subject
2. recognition, e.g. the time taken to do various jobs
3. association, e.g. human beings and birds have two legs; animals and the food they eat and their homes, finding similar objects or the odd one out
4. logic, e.g. descending order is the reverse of ascending order
5. matching of shapes, e.g. two different types of figures (if they have 3 sides, they are triangles; and if 4 sides, they are rectangles or squares)

6. recognition of fractions, as in half-an-hour
7. recognition of flat shapes e.g. shapes with similar properties
8. use of comparative language, e.g. long, longer, longest
9. recognition of another aspect of 0, as a place holder
10. working with 2 Digit numbers, e.g. addition, subtraction
11. identification of shapes and patterns

## 2. Some useful suggestions

A sequence of activities is suggested in the use of these books.

- a. Each lesson is preceded by a 'discussion and demonstration' accompanied by visits to the market or maybe the bank according to the topic.
- b. It might be interesting to ask one of the more able children to come and work on the board while the teacher explains the subject. A different child each day helps boost everyone's confidence and the teacher is not 'partial' to a few.
- c. By now, children are used to working in their individual books. Independent work and a certain amount of tidiness must be encouraged.
- d. More work, similar to the page, is to be done by children on worksheets prepared by teachers in advance.
- e. Leading statements by the teacher form the basis of a fruitful discussion. And the success of a teacher can be measured by the number of questions the children ask.
- f. Children will always tend to make mistakes. It is suggested that mistakes are discussed and children are helped to arrive at the correct answer.

Every child is unique and special. This is a fact that children, whether 3 or 13 years old, are happiest learning at their own pace. Some children work faster than others. This is always a pleasure and must never be curbed. It is up to the teacher to provide more lateral work for their needs. But if a child is a slow learner, more repetition may be required. Handling such children with patience and encouraging them is the teacher's responsibility. A slow learner is not inferior to the rest and must never be allowed to feel small or inadequate. The teacher simply has to give more attention.

If a certain activity seems beyond most of the children in the group, insistence will only make them frustrated. It is best to leave the topic for a later date, when the children have experienced similar activities and are ready for it.

## 3. Praise

At the end of the lesson, if some children have done well, some praise and a coloured star or a smiley pasted at the end of the unit goes a long way in reaffirming to the children that they are making good progress. **Green for Great, Orange for OK, and Red for Redo or Revise.** Even those who have not done the work well, get a RED star.

Corrective remarks, if any, can be made in a 'sandwich' fashion. Away from the rest of the class, a positive remark is made first, such as, 'I like your clips!, Very smart!' A corrective remark follows, 'You could try and write more neatly next time' or 'Your work today was careless.' or 'Complete your work on each page before going to the next.' And, finally, a positive remark again, 'You are an intelligent child, I am sure you will get a Green star next time.' Positive, negative, positive feedback from the teacher does not let the children feel inadequate; they learn that right and wrong are ways of life and one must learn to correct the wrong.

### **E. Lessons**

It is suggested that the teachers spend 40 minutes per lesson. However the time spent on each lesson is entirely on the teacher's discretion and the ability of the students to grasp the concept.



# UNIT 1

## REVIEW AND ASSESS 1

### Teaching objectives

- to revise concepts and skills learnt in the previous year
- to revise ordinal and cardinal numbers
- to practice sequences as taught earlier
- to recall shapes learnt earlier
- to recall concepts of money, length, and weight

### Learning outcomes

Children should be able to:

- demonstrate an understanding of the concepts learnt in the previous year
- work out sums based on the concepts without help

### Teaching materials:

- additional worksheets

### Learning Activity

**Lesson 1:** Fill in the missing numbers. Write more or less. **40 minutes**

Ask the children to count from 1 to 100 in groups or by taking turns.

Activities are based on the children comparing numbers up to 20. They could compare:

- sets of objects such as pencils, erasers and rulers
- numbers written on the board, in numerals and in words
- a group of children wearing glasses and a group who are not

**Task:** Children attempt pages 2 and 3.

**Lesson 2:** Count each set of objects..., Beginning at the bottom of each ladder... **40 minutes**

Refer to lesson 1 for counting practice. Give the children objects to count; they can also count objects in pictures, or around them in the playground or the classroom.

**Task:** Children attempt pages 4 and 5.

**Lesson 3:** Fill in numbers ..., Solve these:

**40 minutes**

Ask the children to count from 1 to 100 and then count backwards from 100 to 0. Explain the terms ascending and descending order. Write a few numbers on the board and ask the children to arrange them in ascending and descending orders.

It is important to explain that numbers written in ascending order are in exactly the opposite order to those written in a descending order.

For example:

9, 22, 50, 61, 78, 91: numbers are in ascending order

91, 78, 61, 50, 22, 9: same numbers in descending order

Recall concepts of addition and subtraction. Work some examples on the board.

**Task:** Children attempt pages 6 and 7.

**Lesson 4:** Game

**40 minutes**

Revise familiar shapes: show the children 3D shapes and ask them to identify them. Draw several shapes on the board and ask the children to count the different types of shapes drawn.

Even though the illustrations on page 8 of MW 2 are all of 3D shapes, a similar activity with 2D shapes is also useful. This exercise should focus on grouping together objects of the same shape (cubes, cuboids, cones, balls, and ovoids) but of different sizes.

**Task:** Children attempt page 8.

**Additional resources**

At the end of the guide are additional worksheets 1, 2, and 3. Use them for reinforcement.

## UNIT 2

# NUMBERS

### Teaching objectives

- to revise ordinal and cardinal numbers, and number names
- to introduce place value
- to teach number names for 3-digit numbers
- to explain symbols depicting 'greater than', 'less than', and 'equal to'
- to reinforce the concepts of ascending and descending order
- to introduce the concept of fractions
- to practise reading and writing fractions

### Learning outcomes:

Children should be able to:

- write number names from 1 to 50
- recognize, read, and write ordinal numbers
- form groups of 10s and identify place value of numbers
- arrange numbers in ascending and descending order
- read and write fractions
- recognize fractions in real-life

### Teaching materials:

- number squares with numbers from 1 to 100
- number lines drawn on the floor
- transparent packets with 10 or 12 marbles in each

### Learning activity:

#### Lesson 1: Ordinal numbers

**40 minutes**

PLEASE remember that the words ORDINAL and CARDINAL are for you only, not for the children. The concept of the size of a set (cardinal number) and the position of a number in a sequence (ordinal number) are more easily explained by practical and board work than by using the actual terms.

These pages revise ordinal numbers. They should be easily remembered when placed in the order taught in the previous books. They were introduced as positions. Children also learn to spell the ordinal positions such as first, second, and third .....

Jumble up the letters of FIRST as RSTIF, SECOND as DONSCE and THIRD as DIRTH ... and so on. Ask the children to find the correct ordinal numbers. Introduce the word anagram.

Ask the children to stand on a numbered line. Each child steps forward when his or her name is called out, announces his or her position, and hops ahead by that many steps. The same may be repeated with steps taken backwards.

Make a chart showing the planets around the Sun, with the name of each planet written below it. The different sizes of the planets should be clearly shown. Point out the positions of planets around the Sun using words like first, second, third, nearest, and farthest. The children should make a list of the planets, starting with the 1<sup>st</sup> planet, closest to the Sun, and going outwards.

Then ask the children to write the names of the planets in ascending or descending order according to size. They may require some assistance in working this out. (If this is too difficult, leave it for the end of the year.)

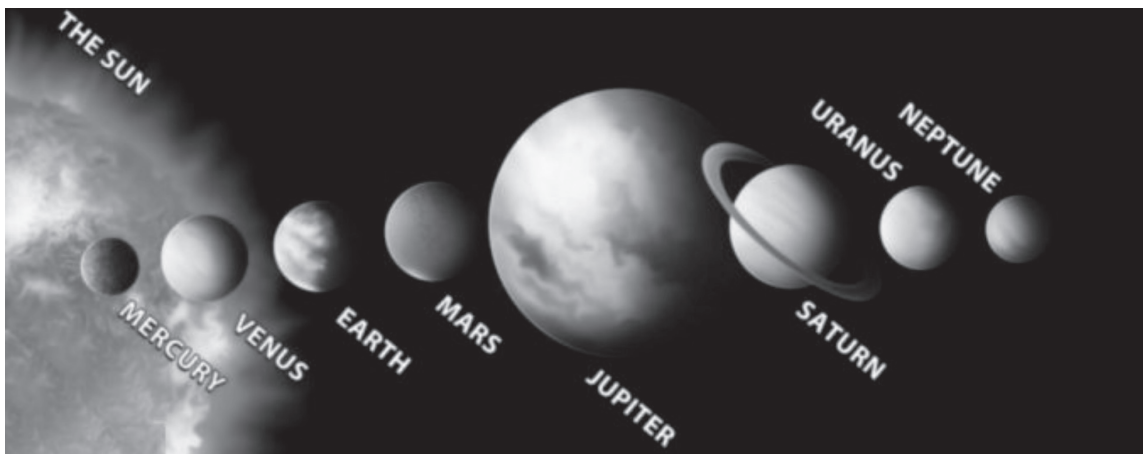

**Task:** Children attempt pages 10 and 11.

**Lesson 2:** Ordinal numbers; number names (continued)

**40 minutes**

The stairs of a multi-storied building are useful to reinforce ordinal numbers. The lowest floor is referred to as the ground floor (not the first floor). In a lift the ground floor is denoted by 0 or G. GROUND FLOOR, FIRST FLOOR, SECOND FLOOR, THIRD FLOOR, and so on.

A wall chart recording the different activities during the weeks of a year is an interesting activity: 1<sup>st</sup> week, 2<sup>nd</sup> week, and so on.

Take the children outside to play this game. 10 positions, 1<sup>st</sup> to 10<sup>th</sup>, are marked in a row on a number line on the ground. Each child picks a random ordinal number card (1<sup>st</sup>, 2<sup>nd</sup>, 3<sup>rd</sup>, 4<sup>th</sup> to 10<sup>th</sup>) from a basket and hangs it on the back of another child.

Ahmed sees Salma with 3<sup>rd</sup> on her back; he shows 3 fingers and Salma stands in the 3<sup>rd</sup> position on the number line. Salma sees Julie with 10<sup>th</sup> on her back, and shows all 10 fingers to Julie. Julie goes to the 10<sup>th</sup> position on the line. After a little guidance, and hesitation, all children find their positions on the line.

This game can be played with positions from 1<sup>st</sup> to 20<sup>th</sup> or 41<sup>st</sup> to 60<sup>th</sup> and so on. Instead of a straight line, a circle with numbers written round the circumference can be used for variety.

**Task:** Children attempt pages 12 and 13.

**Lesson 3:** Cardinal numbers; ordinal numbers (continued) **40 minutes**

Revise the number names and their spellings learned in the previous year. In the age of computers, handwriting is often neglected. Encourage the children to write the number names frequently in a good cursive style. A good deal of practice is required to consolidate the spellings. The concept of place value also needs to be revisited with some activities. The children also need to be introduced to the hundreds place value.

Make number squares with numbers from 1 to 100 and 1<sup>st</sup> to 100<sup>th</sup>.

**Cardinal number square:**

1	2	3	4	5	6	7	8	9	10
11	12	13	14	15	16	17	18	19	20
21	22	23	24	25	26	27	28	29	30
31	32	33	34	35	36	37	38	39	40
41	42	43	44	45	46	47	48	49	50
51	52	53	54	55	56	57	58	59	60
61	62	63	64	65	66	67	68	69	70
71	72	73	74	75	76	77	78	79	80
81	82	83	84	85	86	87	88	89	90
91	92	93	94	95	96	97	98	99	100

## Ordinal number square

1 <sup>st</sup>	2 <sup>nd</sup>	3 <sup>rd</sup>	4 <sup>th</sup>	5 <sup>th</sup>	6 <sup>th</sup>	7 <sup>th</sup>	8 <sup>th</sup>	9 <sup>th</sup>	10 <sup>th</sup>
11 <sup>th</sup>	12 <sup>th</sup>	13 <sup>th</sup>	14 <sup>th</sup>	15 <sup>th</sup>	16 <sup>th</sup>	17 <sup>th</sup>	18 <sup>th</sup>	19 <sup>th</sup>	20 <sup>th</sup>
21 <sup>st</sup>	22 <sup>nd</sup>	23 <sup>rd</sup>	24 <sup>th</sup>	25 <sup>th</sup>	26 <sup>th</sup>	27 <sup>th</sup>	28 <sup>th</sup>	29 <sup>th</sup>	30 <sup>th</sup>
31 <sup>st</sup>	32 <sup>nd</sup>	33 <sup>rd</sup>	34 <sup>th</sup>	35 <sup>th</sup>	36 <sup>th</sup>	37 <sup>th</sup>	38 <sup>th</sup>	39 <sup>th</sup>	40 <sup>th</sup>
41 <sup>st</sup>	42 <sup>nd</sup>	43 <sup>rd</sup>	44 <sup>th</sup>	45 <sup>th</sup>	46 <sup>th</sup>	47 <sup>th</sup>	48 <sup>th</sup>	49 <sup>th</sup>	50 <sup>th</sup>
51 <sup>st</sup>	52 <sup>nd</sup>	53 <sup>rd</sup>	54 <sup>th</sup>	55 <sup>th</sup>	56 <sup>th</sup>	57 <sup>th</sup>	58 <sup>th</sup>	59 <sup>th</sup>	60 <sup>th</sup>
61 <sup>st</sup>	62 <sup>nd</sup>	63 <sup>rd</sup>	64 <sup>th</sup>	65 <sup>th</sup>	66 <sup>th</sup>	67 <sup>th</sup>	68 <sup>th</sup>	69 <sup>th</sup>	70 <sup>th</sup>
71 <sup>st</sup>	72 <sup>nd</sup>	73 <sup>rd</sup>	74 <sup>th</sup>	75 <sup>th</sup>	76 <sup>th</sup>	77 <sup>th</sup>	78 <sup>th</sup>	79 <sup>th</sup>	80 <sup>th</sup>
81 <sup>st</sup>	82 <sup>nd</sup>	83 <sup>rd</sup>	84 <sup>th</sup>	85 <sup>th</sup>	86 <sup>th</sup>	87 <sup>th</sup>	88 <sup>th</sup>	89 <sup>th</sup>	90 <sup>th</sup>
91 <sup>st</sup>	92 <sup>nd</sup>	93 <sup>rd</sup>	94 <sup>th</sup>	95 <sup>th</sup>	96 <sup>th</sup>	97 <sup>th</sup>	98 <sup>th</sup>	99 <sup>th</sup>	100 <sup>th</sup>

Work with little counters which fit in the squares.

### Questions such as these are useful:

1. What comes before 14 (or 14<sup>th</sup>)?
2. What comes after 28 (or 28<sup>th</sup>), 39 (or 39<sup>th</sup>)?
3. What number is written 2 places before 27 (or 27<sup>th</sup>)?
4. What number is 10 places after 39 (or 39<sup>th</sup>)?

‘10 after 39’ changes the tens digit: 39 becomes 49 (10 more always goes to the next line.)

‘2 before 27’ decreases the units digit by 2; 27 becomes 25. The new number may be in the same line or in the previous line. For example, 2 less than 31, i.e. 29 goes into the previous line.

Increasing a number may also give the resultant number in the same line or the next line. 5 after 23 is 28, which is in the same line; 1 after 30, is 31, which is in the next line.

**Task:** Children attempt pages 14 and 15.

### Lesson 4: Place value (up to 3 digits)

**40 minutes**

At this level children are familiar with 1 rupee coins, 10 rupee notes, and 100 rupee notes. Using these is an excellent way to introduce the concept of 3-digit numbers.

Collect several Re.1 coins and Rs10 and Rs 100 notes. Set up a shop where 3-digit prices of toys are marked. Children do shopping with pretend money.

Practical work with cubes (to represent units), rods of 10 cubes (to represent tens) and a slab of 10 rods (to represent a hundred) is essential to introduce the value of 100, and is useful for addition and subtraction later on.

### Work with numbers such as:

1 more than 99; 1 more than 100, using paper money or rods and slabs.

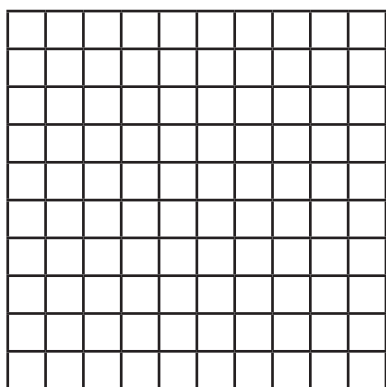

Hundreds  
 $10 \times 10$



Tens  
 $10 = 10 \times 1$



Ones  
1

Once the 3-digit concept is clear, the children can shop for items marked with 3-digit prices, e.g. Rs 153 or Rs 216.

‘Which number is 2 tens more than 340?’ Show this on the number square.

If there is a number square on the wall, the children will find it very simple to find the answer, even if they do not remember the number sequence.

Arrange 3 tables in the classroom and label them ONES, TENS, and HUNDREDS. On each table, place small cards numbered from 0 to 9. Call the children one at a time to each table. Starting with ones and tens, ask each child to choose one card from each table and show them to the class. Two numerals are shown, e.g. 7 TENS and 5 ONES. They call out the number 75. Many 2-and 3-digit numbers can be formed in this manner.

**Task:** Children attempt pages 16, 17, 18, and 19.

### Lesson 5: Place value (continued)

**40 minutes**

Practical work with paper money up to Rs.1, 000 and wooden manipulatives up to 1,000 are easy to understand once the 3-digit concept has been successfully understood.

Ask one child to call out a number, of three digits e.g. 367. Ask another to name and

spell it aloud: three hundred and sixty-seven. Ask the class to name the numbers before and after 367.

Work with numbers such as 299, 399, 499 .... 999 and ask the children to name the numbers before and after each: 298, 299, 300: 998, 999, 1000

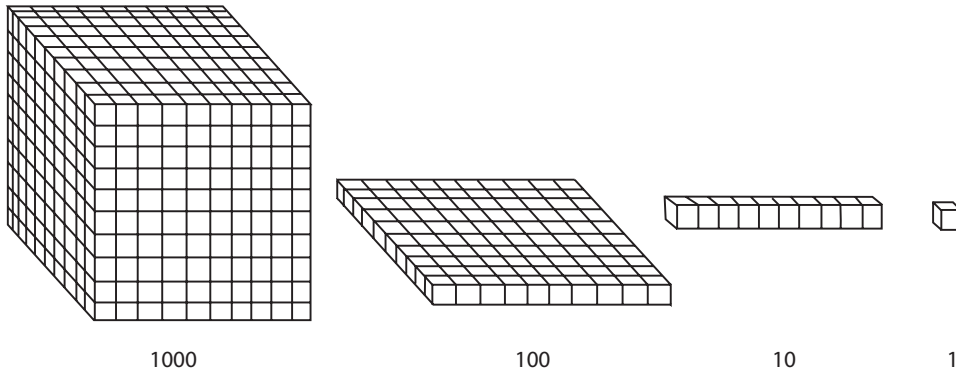

Show this with paper money and cubes. It is too early to go into 4-digit number names.

**Task:** Children attempt pages 20, 21, 22, and 23.

**Lesson 6:** Place value for 3-digit numbers (continued)

**40 minutes**

You need a large wooden dice for this game. Draw the table below on the ground in the play area.

HUNDRED	TENS	ONES
9	9	9
8	8	8
7	7	7
6	6	6
5	5	5
4	4	4
3	3	3
2	2	2
1	1	1
0	0	0

Sara

Beenish

Mushtaq



Select 3 children at a time, for example, Sara, Beenish, and Mushtaq. Let each stand on 0 at the bottom of each column.

Ask Sara to begin with the hundreds. She rolls the dice; it lands on 6 so she moves to 6 and says, 'six hundred.'

Beenish then rolls the dice for the tens column. It lands on 2 so she moves to 2 and says, 'Twenty.' Finally Mushtaq repeats the process for the ones. The dice lands on eight so he moves to 8 and says, 'Eight.'

You call out the number, six hundred and twenty-eight, and write 628 in large numerals and words on the board. Repeat the exercise with different numbers and different groups of children.

**Task:** Children attempt pages 24, 25, and 27.

## Lesson 7: Fractions

40 minutes

Children encounter parts of a whole from a very early age. A birthday cake is shared amongst 10 friends, a chocolate bar is shared by 2, an apple is sliced into 4 pieces, a pizza divided into 6 or 8 parts ... these are real life examples.

At the end of these activities, the children should be able to write fractions correctly with a horizontal bar, and will understand the significance of the numerator and the denominator in a fraction.

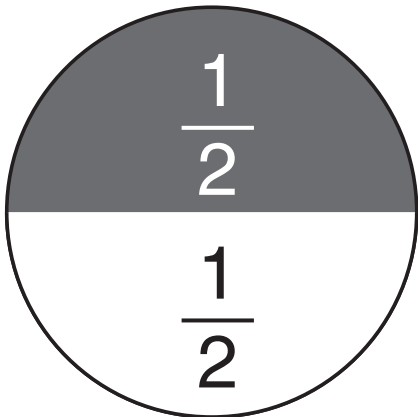

Use plasticine or play dough to make different shapes: square, circle, triangle, rectangle. Cut each one into two equal parts. Explain that each part is 1 of 2, or HALF of the whole. This should be quite easy to understand.

Give the children some worksheets with different shapes, such as squares, triangles, circles, and rectangles drawn on them, in rows. Ask them to draw on the dotted line given to show the halfway point. They should shade only one half of each shape and write  $\frac{1}{2}$  on each part. Refer to worksheet 9.

**Task:** Children attempt pages 28 and 29.

## Lesson 8: Fractions (continued)

40 minutes

The children should understand one-third as, one out of 3 equal parts. Ask them to draw on the dotted lines given to divide into 3 equal parts, on the second row of the shapes on the worksheet (similar to the ones used for  $\frac{1}{2}$ ) that they have worked on, and colour one part, to show  $\frac{1}{3}$ .

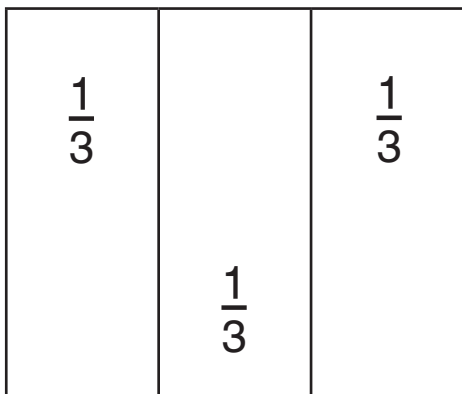

**Task:** Children attempt pages 31 and 32.

**Lesson 9: Fractions (continued) 40 minutes**

Ask, 'How much will each child have if the cake is shared equally amongst 4 children?'

The children will gradually understand the significance of the horizontal bar.

$\frac{1}{2}$  is one out of two equal parts,  $\frac{1}{3}$  is one out of 3 equal parts;  $\frac{1}{4}$  is one out of 4 equal parts and so on. Is there any other method of cutting the cake into  $\frac{1}{4}$ s? Slice it horizontally.

What about a triangular cake?

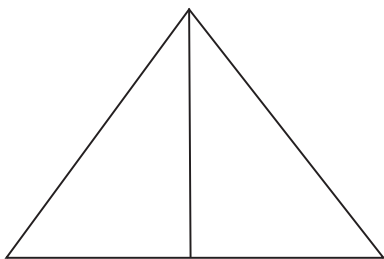

$\frac{1}{2}$

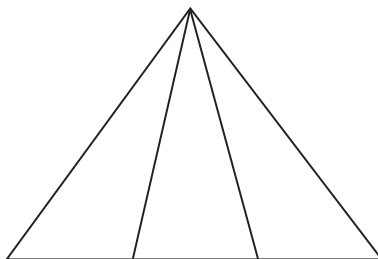

$\frac{1}{3}$

**Task:** Children attempt pages 34, 35, and 36.

**Lesson 10: Fractions (continued)**

**40 minutes**

The next step is to work with a whole group of objects.

A packet contains 12 marbles. Half the packet will contain 6 marbles.

Half of a box of 10 sweets is 5 sweets.

One third of a class of 15 children is 5.

Give each child a set of Lego cubes joined to form a block as shown below. Discuss the fractions  $\frac{1}{2}$ ,  $\frac{1}{4}$ ,  $\frac{1}{8}$  and so on as shown in the diagram. Also show how parts of the whole can be joined together to make the whole again.

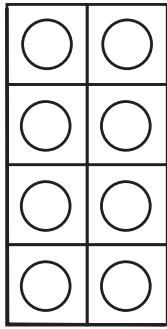

Whole

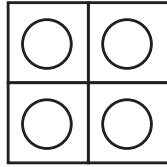

$\frac{1}{2}$



$\frac{1}{4}$



$\frac{1}{8}$

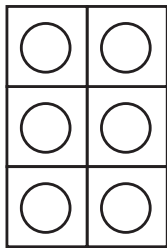

$\frac{3}{4}$

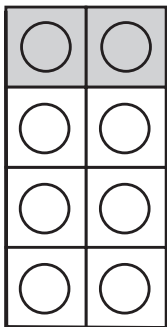

$\frac{1}{4} + \frac{3}{4}$

=

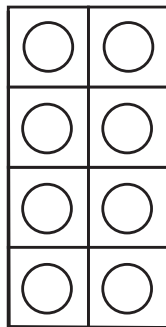

=  $\frac{4}{4}$

=

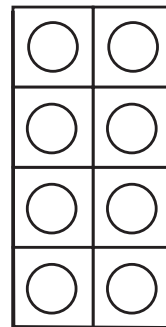

= 1 whole

Apply fractions to every day life. Arrange a class picnic. On the menu there are cakes, pizzas, some apples, and a variety of fruit that can be cut into equal parts; also drinks such as water and juice.

Children see that a whole can be cut into equal parts called fractions. Ask questions such as:

1. How many parts have you broken the chocolate bar into?

(Ans: 10. There are 10 equal pieces. Each piece is  $\frac{1}{10}$  of the whole)

2. How many parts has the pizza been cut into?

(Ans: 8. There are 8 equal pieces. Each piece is  $\frac{1}{8}$  of the whole.)

3. How many slices of bread in a loaf?

(Ans: There are 12 slices. Each slice is  $\frac{1}{12}$  of the whole loaf.)

Arrange a game of paper toss. Put a basket in the middle of the classroom. Let the children make 10 balls of paper, 5 red, 2 blue, and 3 yellow. Allow each child to take turns to toss the paper balls into the basket. 'What fraction of the balls landed in the basket? What fraction did not land in the basket? What fraction of the balls in the basket are yellow? Red?

**Task:** Children attempt page 38.

**Additional resources:**

At the end of the guide are worksheets 4 to 9. Use them for reinforcement.

## UNIT 3

# NUMBER OPERATIONS

### Teaching objectives

- to teach addition and subtraction of 2-and 3-digit numbers, according to place value
- to introduce basic multiplication
- to introduce multiplication tables up to 5, and of 10
- to teach basic division

### Learning outcomes

Children should be able to:

- add and subtract 2-and 3-digit numbers using place value
- recite from memory multiplication tables up to 5 and the 10's table
- do simple multiplication using tables
- do simple division using tables
- solve word problems involving all four mathematical operations

### Teaching materials:

- beads
- egg trays
- pencils
- number grid
- blocks of ones, tens, and hundreds

### Learning activities

#### Lesson 1: Addition

**40 minutes**

Math Wise 2 lays great stress on number operations. The children work on each operation in great detail. The concepts of 'carrying over' and 'borrowing' are made clear. A lot of extra work is necessary. Show how numbers are arranged vertically. Introduce the concept by adding ones that add up to more than ten.

**Task:** Children attempt page 41.

## Lesson 2: Addition of 2-or 3-digit numbers

40 minutes

Start by revisiting the idea of representing numbers as ones, tens, and hundreds. Give each child a set of blocks, and ask them to form numbers using the blocks. For example, 234 can be represented as 2 hundreds, 3 tens, and 4 ones. One child may represent it as 2 hundreds and 34 units, or 23 tens and 4 ones, or even 234 ones. At this point, consolidate the idea of groups of ten. A group of 10 ones makes 1 ten, and a group of 10 tens makes 1 hundred. Repeat this exercise until the children are comfortable with 3 digit numbers.

Draw these illustrations on the board and explain addition of ones and tens

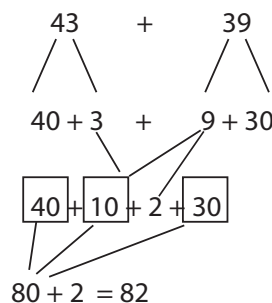
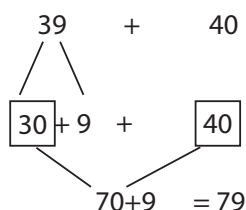

Then, ask them to put together 2 hundreds, 3 tens, and 4 ones with 1 hundred, 6 tens, and 7 ones. This means adding the two groups:

H	T	O
2	3	4
+	1	6
		7

Remind them: Always start addition and subtraction from the ones, and move to the left.

As they get to a group of 10 in any column, they 'bind' it together and carry it over as 1 to the next higher denomination.

Here, 4 ones and 7 ones make 11 ones, which is 1 group of 10 and 1 ones.

So that 1 group of 10 moves over to the tens and you have 1 left in the ones column.

H	T	O
	#####	
2	3	4
+	1	6
		7
		1

Now, 1 ten (carried over from ones), 3 tens and 6 tens make 10 tens.

H	T	O
#####	#####	
2	3	4
+ 1	6	7
	0	1

10 tens makes one group of a hundred and no tens are left.

H	T	O
#####	#####	
2	3	4
+ 1	6	7
	0	1

Now add the numbers in the hundreds column.

H	T	O
#####	#####	
2	3	4
+ 1	6	7
4	0	1

2 hundreds and 1 hundred and 1 hundred (carried over from the tens) makes 4 hundreds. The final answer is 4 hundreds, 0 tens and 1 ones, OR 401.

Repeat this exercise several times till the children are comfortable with the idea of carrying over.

As a fun exercise, give each one a worksheet with an illustration such as this.

Each section has a number written on it; each number is the sum of numbers such as these:

4 5	7 9	2 4	5 0
+ 3 8	+ 1 1	+ 6 4	+ 5 0
-----	-----	-----	-----

Ask the children to colour the numbers to be added and the answer in the same colour.

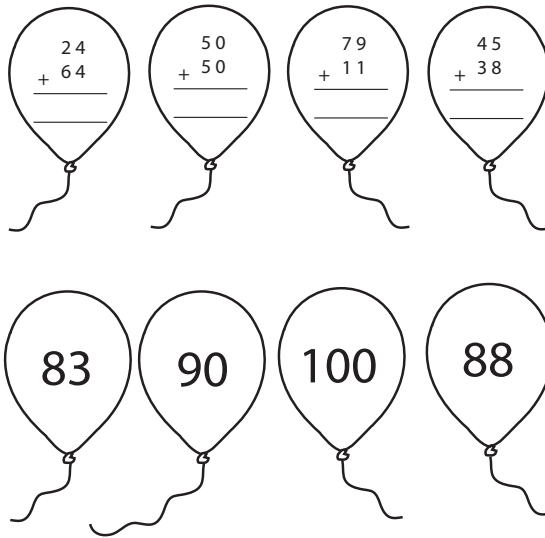

**Task:** Children attempt pages 42, 43, and 44.

**Lesson 3:** Addition of 2-and 3-digit numbers (continued )

**40 minutes**

Squares cut out from a paper grid can be useful in representing O, T, and H. One one is represented by a small square, one ten by a strip of 10 small squares, and one hundred by a large square of 100 small squares. Give out squares, strips, and small squares of paper to groups of children. They can use these to represent numbers.

This diagram represents:  $300 + 70 + 7 = 377$  Show the children how to write out the addition problems and represent carrying over.

**Hundred**

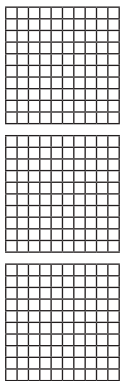

**Tens**

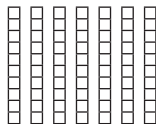

**Ones**



$$300 + 70 + 7 = 377$$

**Task:** Children attempt pages 45, 47, and 48.



## Lesson 4: Subtraction

40 minutes

Subtraction may be introduced in a similar fashion. For example:

$$\begin{array}{r} \text{H} \quad \text{T} \quad \text{O} \\ 2 \quad 3 \quad 4 \\ - 1 \quad 5 \quad 7 \end{array}$$

Reiterate the concept of groups of 10. Emphasize that addition and subtraction of numbers **MUST ALWAYS** start from the ones digit. (Later, multiplication also starts from the ones column and moves left. Only division starts from the column on the left and moves to the ones.)

Think:  
Do I need to regroup?

Think: I can regroup 1 ten as 10 ones. Now I can subtract 7 ones from 12 ones and 3 tens from 4 tens. The answer is 15

	Tens	Ones
	<input type="text"/>	<input type="text"/>
-	5	2
	3	7
<hr/>		





	Tens	Ones
	4	12
-	5	2
	3	7
<hr/>		
	1	5

The mathematical term to use for 'borrowing' is 'regrouping', but, to make it interesting for the children, a 'borrowing' story is fun.

The Ones could not give away 7 from the 4 they had, so they went knocking on the Ten's door to borrow one ten. One ten opened out to make 10 ones, because Tens can lend only in bundles of 10 ones. The Ones house has 10 (borrowed) + 4 = 14 ones. The Ones house gave away 7 ones, and had 7 ones left.

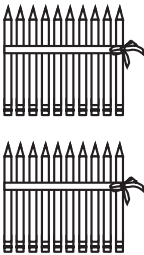
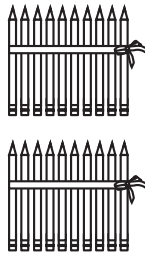
In the house of Tens, they had 2 tens left, and they had to give away 5 tens. They could not do that, so they went knocking on the Hundred's door to borrow 1 hundred, or 10 tens. (A Hundreds house has only groups of 10) So, the Tens borrowed 10 tens.

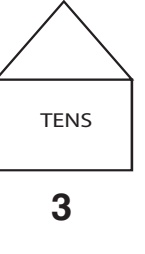
The Tens house had: 10 (borrowed) + 2 = 12 tens. 5 tens were given away from the 12,

HUNDREDS	TENS	ONES
		
		
<hr/>	<hr/>	<hr/>
2	3	4
- 1	5	7
<hr/>		

and there were 7 tens left. In the house of Hundreds, there was 1 hundred left after 1 hundred (or 10 tens) was lent to the Tens house.

1 hundred taken away from 1 hundred, leaves none. That makes 0 hundreds, 7 tens, and 7 ones. The final answer is 77.

OR	H	T	O
	2	3	4
-	1	5	7
	0	7	7

Repeat such examples several times until the children are comfortable with the concepts of 'carrying over' and 'borrowing'. They can then represent this in writing.

**Task:** Children attempt pages 50, 51, and 52.

**Lesson 5:** Subtraction of 2 and 3-digit numbers (continued) **40 minutes**

Based on last year's work, a chart with these types of numbers will be useful...



$$32 \pm 57 = 89$$

( $89 > 32$  and  $57$ ; and  $2 + 7 = 9$  ... the correct sign is +)

$$69 \pm 43 = 26$$

( $9 - 3 = 6$  and  $26 < 69$  ... the correct sign is -)

$$132 \pm 234 = 366$$

( $366 > 132$  and  $234$ , and  $4 + 2 = 6$  ... the correct sign is +)

$$495 \pm 213 = 282$$

( $5 - 3 = 2$ ; and  $282 < 495$  ... the correct sign is -)

Do remember that the concepts of borrowing and carrying over should not be rushed. Take as much time as is needed to consolidate the concept. Do a lot of hands-on activities.

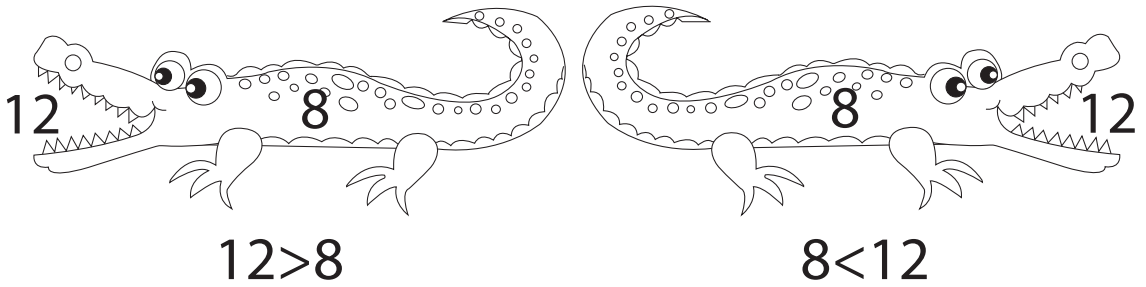

Explain the symbols > than and < than

The story goes ... the greedy crocodile always has his mouth open to eat the bigger number, while the smaller number is already in its stomach.

More worksheets with colouring by working out addition and subtraction sums. Refer to Lesson 2.

**Task:** Children attempt pages 53 and 54.

### Lesson 6: Multiplication

**40 minutes**

Multiplication is repeated addition. Start with a simple activity. Call 3 children to the front of the class. Call 3 more, then, call 3 more. As they stand together in 3's, call out the total number of children

- III (3) = III (3) One 3 is 3.
- III (3) + III (3) = III III (6) Two 3s are 6
- III (3) + III (3) + III (3) = III III III (9) Three 3s are 9.

The children follow the pattern and complete it as far as Ten 3s are 30.

Similar activities may be carried out with pictures of 3 legs of a camera tripod, 3 toes of some birds, or 3-leaf shamrock that is the symbol of Ireland.

- 4 legs of a mammal
- 5 fingers of a hand
- 6 sides of a cell in a beehive
- 7 colours of the rainbow, or days in a week
- 8 legs of an octopus

It is interesting to create number squares for the wall, with multiples of different numbers in different colours: multiples of 2 in red, multiples of 3 in blue, multiples of 4 in green, and multiples of 5 in yellow. Look for the numbers which are



multiples of 2 and 3, or 2 and 5 and so on.

Work with crosses like this:

FOR ADDITION:

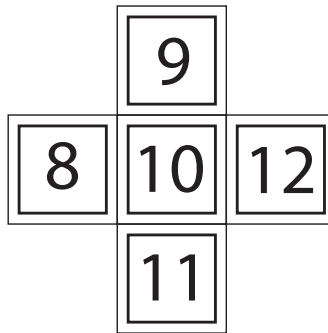
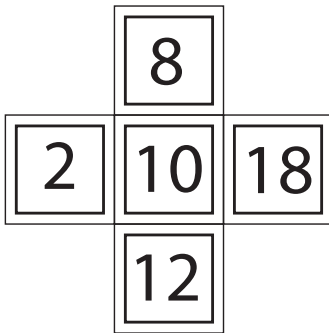
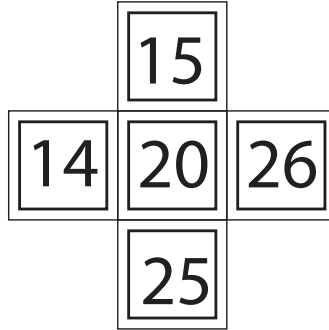
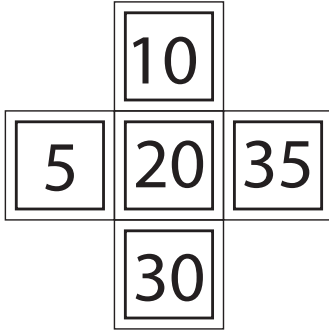

Leave one of the numbers out, and help children to work out the missing number.

**Task:** Children attempt pages 56, 57, and 58.

### Lesson 7: Multiplication (continued)

**40 minutes**

Even though calculators and mobile phones are used for multiplication, it is important that children memorize the tables. This helps to improve long term and short term memory tremendously.

Help the children make their own multiplication tables and display them in the classroom.

Give the children a grid with numbers from 1 to 100. Ask them to colour numbers in jumps of 2 in red; jumps of 3 in green; jumps of 4 in yellow; jumps of 5 in pink; jumps of 10 in blue. Ask them which numbers are coloured in both red and blue? Which numbers have 3 colours?

(OR use different number squares for different tables)

x	1	2	3	4	5	6	7	8	9	10
1	1	2	3	4	5	6	7	8	9	10
2	2	4	6	8	10	12	14	16	18	20
3	3	6	9	12	15	18	21	24	27	30
4	4	8	12	16	20	24	28	32	36	40
5	5	10	15	20	25	30	35	40	45	50
6	6	12	18	24	30	36	42	48	54	60
7	7	14	21	28	35	42	49	56	63	70
8	8	16	24	32	40	48	56	64	72	80
9	9	18	27	36	45	54	63	72	81	90
10	10	20	30	40	50	60	70	80	90	100

Create a multiplication grid as shown above and display it in the classroom. It is a good aide-mémoire.

**Task:** Children attempt pages 59 to 63.

### **Lesson 8: Multiplication (continued)**

**40 minutes**

Plenty of practice with multiplication exercises is necessary. Refer to the lessons above for practical as well as theoretical exercises.

**Task:** Children attempt pages 64, 65, and 66.

### **Lesson 9: Division**

**40 minutes**

Division is repeated subtraction.

Give a child a bag of 10 pencils and ask him/her to give 2 to one friend in the class. Then, give 2 more pencils to a second friend, 2 to a third friend, and so on until no more pencils remain.

$$10 - 2 = 8 \quad \text{Take 2 out of 10 once: 8 left.}$$

$$10 - 2 - 2 = 6 \quad \text{Take 2 out of 10 twice: 6 left.}$$

$$10 - 2 - 2 - 2 = 4 \quad \text{Take 2 out of 10 three times: 4 left.}$$

$$10 - 2 - 2 - 2 - 2 = 2 \quad \text{Take 2 out of 10 four times: 2 left.}$$

$$10 - 2 - 2 - 2 - 2 - 2 = 0 \quad \text{Take 2 out 10 five times: 0 left.}$$

$$10 - 2 = 8$$

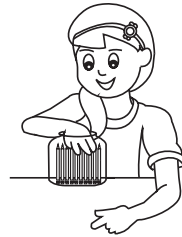

$$10 - 2 - 2 = 6$$



$$10 - 2 - 2 - 2 = 4$$



$$10 - 2 - 2 - 2 - 2 = 2$$



$$10 - 2 - 2 - 2 - 2 - 2 = 0$$



How many friends were given pencils? Explain the process the child followed to distribute the pencils to his/her friends. Explain that this is the opposite of multiplication. Give more examples to explain the fact that multiplication and division are flip sides of a coin. Relate the process to the multiplication tables.

In this case 5 children receive 2 pencils each. Use the notation of division,  $10 \div 2 = 5$ ; the children should learn to write this sign for division.

Repeat this for multiplication, and explain to the class that **JUST AS ADDITION AND SUBTRACTION ARE OPPOSITES OF EACH OTHER, MULTIPLICATION AND DIVISION ARE ALSO OPPOSITES OF EACH OTHER**

**Task:** Children attempt pages 68 and 69.

**Lesson 10:** Division (continued)

**40 minutes**

Let the children work in groups for this activity. Give each group 12 beads and an egg tray. Ask them to divide the beads equally in the grooves of the tray in all possible ways.

They might do it in the following ways:

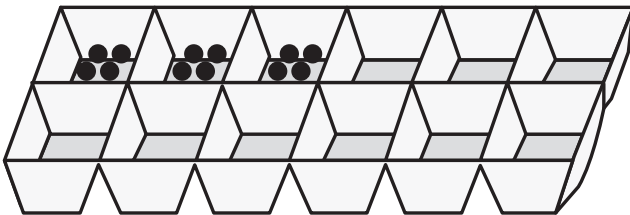

- 4 beads in 3 compartments each ....

$3 \times 4 = 12$       Three 4s equal 12 ( $4 + 4 + 4 = 12$ )

$12 \div 4 = 3$       12 divided by 4 equals 3

( $12 - 4 = 8$ ;     $8 - 4 = 4$ ;     $4 - 4 = 0$ )

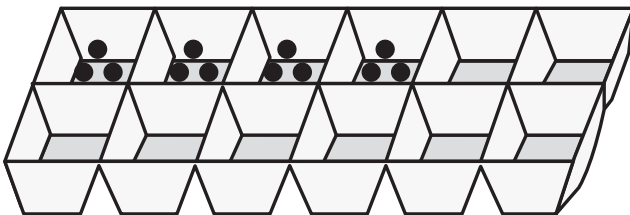

- 3 beads in 4 compartments each ...

$4 \times 3 = 12$       ( $3 + 3 + 3 + 3 = 12$ )      Four 3s equal 12

$12 \div 3 = 4$       ( $12 - 3 = 9$ ;     $9 - 3 = 6$ ;     $6 - 3 = 3$ ;     $3 - 3 = 0$ )

12 divided by 3 equals 4

- 6 beads in 2 compartments each

$2 \times 6 = 12$       ( $6 + 6 = 12$ )      Two 6s equal 12

$12 \div 6 = 2$

( $12 - 6 = 6$ ;     $6 - 6 = 0$ )      12 divided by 6 = 2

- One bead each in 12 boxes

$$12 \times 1 = 12 \quad (1 + 1 + 1 + 1 + 1 + 1 + 1 + 1 + 1 + 1 + 1 + 1 = 12)$$

Twelve 1s = 12

$$12 \div 1 = 12 \quad (12 - 1 = 11; 11 - 1 = 10; 10 - 1 = 9; 9 - 1 = 8; 8 - 1 = 7; 7 - 1 = 6; 6 - 1 = 5; 5 - 1 = 4; 4 - 1 = 3; 3 - 1 = 2; 2 - 1 = 1; 1 - 1 = 0)$$

12 divided by 1 equals 12

- 12 beads in one compartment

$$1 \times 12 = 12 \quad (12 = 12)$$

One 12 equals 12

$$12 \div 12 = 1 \quad (12 - 12 = 0 \quad 12 \text{ divided by } 12 \text{ equals } 1)$$

You need to go over the various aspects of multiplication being the opposite of division for 12 and its various factors, and it will be useful to work with other numbers as well.

A similar activity will help the children understand that there may be more than one way of distributing the beads or pencils. This might happen with the number of stickers someone brings for his class friends, or the balloons that need to be distributed amongst the children attending a birthday party.

The concept is important for the children to understand. Compared to addition and subtraction, multiplication and division are slightly more complex concepts. They need to decide whether a situation calls for repeated addition (multiplication) or repeated subtraction (division), and finally realize that **MULTIPLICATION AND DIVISION ARE OPPOSITES OF EACH OTHER.**

Work with more numbers:

Two 5's (two groups of 5) OR Five 2's (five groups of 2) AND

From 10, give away 5 each time ( $10 - 5 = 5$ ;  $5 - 5 = 0$  twice)

OR from 10, give away 2 each time ( $10 - 2 = 8$ ;  $8 - 2 = 6$ ;  $6 - 2 = 4$ ;  $4 - 2 = 2$ ;  $2 - 2 = 0$  ... 5 times)

Let the children work in groups for this activity.

At Hassan's twelfth birthday, his friends want to place candles at the intersections of the chocolate sticks placed as shown on his beautiful chocolate cake:



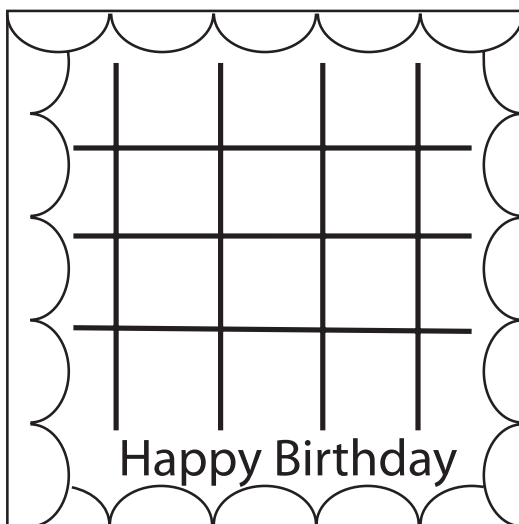

This is a practical representation of the 1<sup>st</sup> problem above, with beads in an egg tray.

There are 12 intersections, so 12 candles can easily be placed.

$$4 \times 3 = 12 \quad 3 \times 4 = 12 \quad 12 \div 3 = 4 \quad 12 \div 4 = 3$$

Here a couple of practical ways to demonstrate multiplication by 0:

1. 1 horizontal stick with no vertical sticks gives 0 points of intersection.

$$1 \times 0 = 0 \quad 0 \times 1 = 0$$

2. Peter gives Susan 5 pens 0 times or 0 pens 5 times

**Task:** Children attempt pages 70, 71, and 72

**Additional resources:**

At the end of the guide are additional worksheets 10 and 11. Use them for reinforcement.

## UNIT 4

# MEASUREMENT: LENGTH, WEIGHT, AND CAPACITY

### Teaching objectives

- to introduce measurement of length, using the metric system
- to introduce measurement of weight, using the metric system
- to introduce capacity, using the metric system
- to encourage children to use the above measurements in real life situations

### Learning outcomes

The children should be able to:

- demonstrate an understanding of the concepts of length, weight, and capacity
- use metric units of length, weight, and capacity in daily life
- measure real objects using everyday instruments
- compare the weights, lengths, and capacities of different objects
- solve problems using these concepts

### Teaching materials:

- metre ruler and tape measure
- ribbons or streamers
- measuring wheel

### Learning activity

#### Lesson 1: Length

**40 minutes**

Start the lesson with a story about ancient times, when man used various standards to measure length, for example the span of hand, footsteps, and cubits (a cubit is roughly equal to the length of the forearm). Make the plot of the story such that, at the climax, two men end up having a fight because both men used a cubit to measure a certain length, but one man used a longer cubit than the other.

Let the children brainstorm the different ways in which the problem could have been resolved. Using a standard measurement would be an obvious solution. Tell them that a marked portion of the length of a platinum iridium bar, kept at a standard temperature, represents 1 metre and is used all over the world as a standard measure of length.

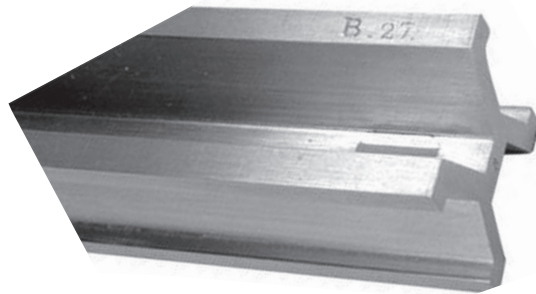

Platinum iridium bar

Show them a picture of the bar. Show the children a metre ruler (1 m). Let them compare the lengths of various objects they see around them (window panes, doorways, his or her own height, the height of a table, etc.) with the metre ruler.

Remember:

- a room, a tripod stand for a camera, or a building has height
- a road, a dupatta, the screen of a laptop, or a cellphone has length and width (or breadth)
- a table has height, and its tabletop has length and breadth (or width)
- a sheet of chart paper or the floor of a room has length and breadth (or width)

Encourage them to examine a metre ruler thoroughly, and see that it is divided into 100 equal divisions; explain that each small division is called a centimetre. Let them compare objects of shorter lengths, using centimetres as units of measurement.

Display an assortment of rulers and tapes. Children need to handle the instruments and feel comfortable with the numbers and the divisions on the scales. Once they are ready, they can use the edges of rulers to draw lines of different lengths.

**Task:** Children attempt pages 74, 75, 76, and 77.

## Lesson 2: Length (continued)

**40 minutes**

Take the children out for an excursion to a fabric shop and show them how the shopkeeper uses a metre ruler to measure lengths of fabric. If time permits, take them to a doctor's surgery, a tailor's shop, and a shoe shop, to show them how the lengths of the different parts of the body are measured by a tailor, the height is measured by the doctor, and the length of the feet by the shoe shop assistant (sizes 3, 4, 5, and so on).

It is important to point out that a metre rod is used horizontally to measure length, e.g. of fabrics, ribbons, or a tabletop, and vertically to measure height, e.g. of people or doors.

Take the children out into the playground and play Statues. Call out instructions such as, 'Statue with your hands 10 cm apart', 'Legs 50 cm apart', and so on. As the children

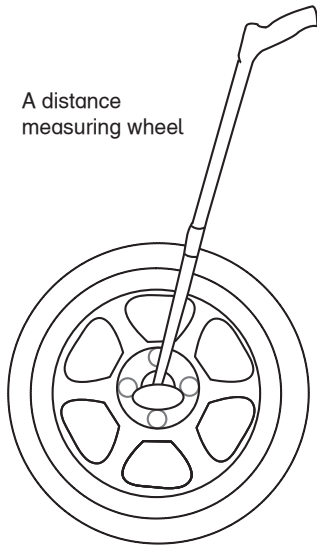

stand displaying their estimated lengths, use a measuring tape to check their accuracy.

Divide the children into groups. Give each group a distance measuring wheel, with a circumference of 1 m, measure the circumference with a tape, and let the class see. Mark a point on the circumference. They can roll it around the playground and measure the lengths of various areas.

The children can decorate the classroom with ribbons and streamers; they should estimate the lengths of the ribbons or streamers required, and cut them to size accordingly.

**Task:** Children attempt pages 78 and 79.

### Lesson 3: Weight

**40 minutes**

An introduction to weight is similar to that of length. The unit for measurement of weight is the gram (g), but it is the kilogram (kg) that is more commonly used because the gram is too small a unit for use in daily weight measurements (such as meat, vegetables, and fruit for the kitchen, or cement for building a wall) and needs very specialized scales. Valuable metals, chemicals, and impurities in water are measured in grams. A visit to a local shop or a market can be useful. The children can see for themselves the different measuring scales and form an idea of quantities.

It is important that they learn to compare the weights of two different objects such as a cotton wool ball and a golf ball, by first holding one in each hand, and then putting one on each pan of a balance.

**Task:** Children attempt pages 80 and 81.

### Lesson 4: Weight (continued) 40 minutes

It can be fun to use a common balance or scales in the classroom. Let the children work in groups. Give them various pairs of objects, such as a pen in a box, a packet of biscuits, a packet of marbles, and a mobile phone.

Ask them to guess which of the two is heavier (as was done in the last lesson). The side of the balance containing the heavier object will go down, and the one containing the lighter object will rise. Ask them to arrange a few objects according to their relative weights..... ascending order and descending order.

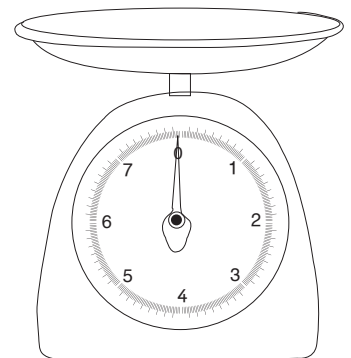

Then, various objects can be weighed on a metric balance that display weights instantly. Each child can see his or her own weight on weighing scales too.

Bring 10 kg, 1 kg, 500 g, 100 g, and smaller weights to class. Let the children feel the weights in the palms of their hands. Now ask them to compare the weights of some classroom objects to the standard measures. They may use the balance to check whether their estimates are correct. Discuss the suitability of various weights to measure different objects.

Which units are suitable to measure the weight of:

- a cabbage (500 g and 100 g)?
- a bag of flour or rice (1 kg, 5 kg or 10 kg)?
- a whole fish or a slice of fish (1 kg and a few 100 g)?
- How many packets of biscuits will weigh as much as a tin to hold the biscuits?

Justify their choices by practically measuring the various food items.

**Task:** Children attempt pages 82 and 83.

### **Lesson 5: Measurement of capacity**

**40 minutes**

The capacity of a container refers to the amount it can hold. The unit for measuring capacity is the litre: for example, a bottle can hold 1 litre of water. The same bottle can also hold 1 l of juice, 1 l of milk or 1 l of tomato sauce, though the various liquids may have different weights

The capacity of the container has nothing to do with its weight. The weight of 1 l of water is 1 kg.

Compare the weights of:

- 1 l of sauce
- 1 l of tomato juice
- 1 l of oil

(Why does oil from spills float on water? Oil is lighter than water and oil and water do not mix.

Why does a slab of wood float on water? Why does a metal spoon sink in water?)

Show them containers that can hold  $\frac{1}{2}$  a litre,  $\frac{1}{4}$  litre, or 5 litres of water. These containers will hold the same amount of juice, or oil, or milk (measured in litres). The weight of each will be different. Let them form an idea about the quantity each of these measures represents.



A visit to the petrol pump or a CNG station is quite awe-inspiring. (A great deal of supervision is necessary to make sure that the children do not touch anything there.) Children watch the fast-changing numbers on the screen; they realize that these moving numbers show the number of litres of petrol going into the car.

Guessing the capacity of various containers also makes an interesting activity... a watering can, a mug, an empty hand lotion bottle, an empty jam jar, a frying pan (difficult!) or a clay pot.

Introduction to millilitres begins here, but the unit is too small for the children to actually guess capacities in millilitres.

It is important, however, to show various capacities so that children realize that  $1000 \text{ ml} = 1 \text{ litre}$ , and  $500 \text{ ml} = 1/2 \text{ litre}$ .



**Task:** Children attempt pages 84, 85, and 86.

**Additional resources:**

At the end of the guide are additional worksheets 12 and 13. Use them for reinforcement.

## UNIT 5

# TIME AND DATE

### Teaching objectives

- to explain how to tell the time by looking at a clock
- to introduce the concepts of a.m. and p.m.
- to explain the division of one hour into halves and quarters of an hour
- to estimate the times taken to complete routine activities
- to practice reading dates from a calendar
- to explain the lunar and solar calendars

### Learning outcomes

Children should be able to:

- read different times on a clock
- differentiate between a.m. and p.m.
- differentiate between the lunar and solar calendars
- read dates from a calendar
- name the months of the lunar calendar

### Teaching materials:

- clock with movable hands
- a 12-hour clock and a 24-hour clock
- different types of digital clocks
- lunar and solar calendars

### Learning Activity

#### Lesson 1: Time

**40 minutes**

In the previous year the children were introduced to months, weeks, days, hours, minutes, and seconds. They also learned how to tell the time, having played with toy clocks with movable hands and seeing time displayed on wristwatches, computers, and mobile phones. Their understanding of time comes from the fact that all their activities are time related.

For example: Today is Monday, 16 March, 2014; a new year begins on 1<sup>st</sup> January every year; Christmas falls on the 25<sup>th</sup> December every year; my birthday is on 12<sup>th</sup> July;

summer holidays start on 15<sup>th</sup> May; games lesson is every Wednesday in the 3<sup>rd</sup> period which begins at 11.15 a.m.; breakfast is at 7 am; school starts at 9 a.m.; dinner time is 7 pm; bedtime is 9 p.m., and so on. Refer to events like 'Lunch is at a quarter to 2 in the afternoon,' as 1.45 pm, and 'the first lesson begins at half-past nine' as 9.30 or 9.30 a.m.

Use a real clock (24 hour clock if possible) to show the 12 hours before noon (ante meridian – a.m.) and the 12 hours after noon (post meridian – p.m.) with explanations for half past, a quarter past, and a quarter to. They memorize the positions of the hands of the clock at these times. Now ask them to stand in a circle and to use their arms like the hands of a clock. As you call out different times, they show the time by rotating their arms and holding them in the required positions.

**Task:** Children attempt pages 88 and 91.

### **Lesson 2:** Time (continued)

**40 minutes**

On a digital clock ask children to look for times when 2 numbers are repeated. For example: 03:30; 05:50; 12:12; 12:21; 13:13; 13:31; 15:15; 15:51; 21:21 21:12.

Find other patterns in time:

11:11; 22:22

01:23; 12:34; 23:45

11:22; 11:33; 11:44; 11:55

22:11; 22:33; 22:44; 22:55

(Time cannot be 33:33 OR 09:90 OR 17:71. Why not?)

**Task:** Children attempt pages 92, 93, and 94.

### **Lesson 3:** Time (continued)

**40 minutes**

Ask the children questions such as:

- Where are you at midnight?
- What do you do at 8 a.m.?
- What do you do at 11 a.m.?

Each child lists some of his or her activities, time-wise, beginning in the morning.

Explain the use of a.m. and p.m. Give the children plenty of practice before attempting the exercises.

**Task:** Children attempt pages 95 and 96.

### **Lesson 4:** Date

**40 minutes**

Give each child 12 square sheets of paper, and help them to prepare a calendar for the



year. They prepare 1 page for each of the 12 months of a year, with the help of a wall calendar. Each child adds a suitable picture for each month. Display the calendars and ask why they chose a particular picture for that month.

Talk about the number of days in the 12 months:

How many months in a year have 30 days each?

How many months in a year have 31 days each?

There is one month which has less than 30 days? (Discuss 28 and 29 days in February, and leap years.)

Ask the children to mark in red on the calendar the following: Eid, Muharram, Christmas, May Day, Independence Day, and other national and international holidays.

The knuckles of both fists placed together help in memorizing the number of days in each month.

Hold both the fist together in front of you. Start with January on the left little knuckle of your left hand. Other months have 30 days, except February, which has 28 or 29 days.

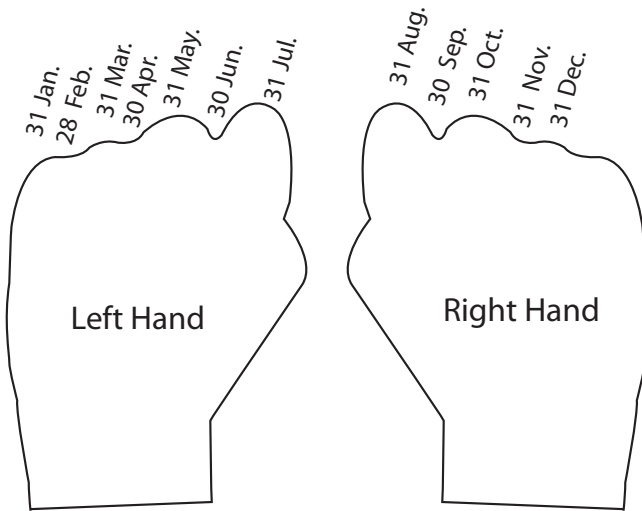

An old rhyme to remember the number of days in each of the months of the year:

30 days have September,  
April, June, and November:  
All the rest have 31,  
Except February,  
Which has 28 days clear,  
And 29 in each leap year.

Draw a number line on the board, with numbers from 1 to 12 written (as shown below) for each month of the year.

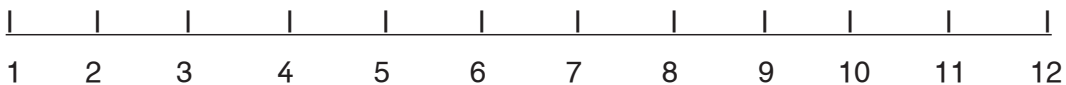

The initial letters of the 12 months are:

**A, A, D, F, J, J, J, M, M, N, O, S**

Children write these letters on the number line in order:

January, February, March ..... up to December.

Ask the children to write the following:

- his or her birthday
- siblings' birthdays
- parents' birthdays
- best friend's birthday
- teacher's birthday

Ask the children to find number patterns in the dates of the calendar. For example: is there a pattern in the dates for all Fridays or Tuesdays in a month? Does each day, for example Saturday, appear 4 times in a month? Which are the months when some days appear 5 times?

Here are some interesting points about the year 2014:

The pattern of the year 2014 is identical to that of 1947, the year Pakistan was born.

**EACH OF THESE DATES FELL ON A FRIDAY:**

04.04.2014 (4 April was a Friday)

06.06.2014 (6 June was a Friday)

08.08.2014 (8 August was a Friday)

10.10.2014 (10 October was a Friday)

12.12.2014 (12 December was a Friday)

**EACH OF THESE DATES FELL ON A SUNDAY:**

01.01.2014 (1 January was a Sunday)

02.02.2014 (2 February was a Sunday)

03.03.2014 (3 March was a Sunday)

Ask the children to complete the list ....

**Task:** Children attempt pages 98, 99, and 100.

**Lesson 5: Date (continued)**

**40 minutes**

A reference to the lunar calendar is necessary, as Eid and Muharram do not fall on the same day every year. The lunar calendar follows the phases of the Moon. Dates and times of the start of each month are available on the net. (There are 13 months in the lunar calendar this year.)



Explain that in the lunar calendar the months are measured according to the phases of the moon. Name the important months and religious festivals that Muslims celebrate according to the lunar calendar.

Explain that Islamic years are counted from the event of the Hijra of the Prophet Muhammad (PBUH). Ask the children to repeat the names of the Islamic months after you. They should then memorize the names of the months.

- |                      |                      |
|----------------------|----------------------|
| 1. Muharram          | 7. Rajab-ul-Murjjab  |
| 2. Safar-ul-Muzaffar | 8. Shaban-ul-Moazzam |
| 3. Rabi-ul-Awwal     | 9. Ramzan            |
| 4. Rabi-us-Sani      | 10. Shawwal          |
| 5. Jumad-al-Awwal    | 11. Zulqaadah        |
| 6. Jumad-as-Sani     | 12. Zul-Hajj         |

**Task:** The children memorize the names of the months in the Islamic calendar.

**Additional resources:**

At the end of the guide is an additional worksheet 14. Use it for reinforcement.

## UNIT 6

# GEOMETRY

### Teaching objectives

- to revise 2D shapes previously learnt
- to teach 2D shapes through practical activities
- to introduce new geometric terms
- to explain the difference between straight and curved lines
- to introduce vertical, horizontal, and oblique lines
- to work out simple problems involving measurements

### Learning outcomes

Children should be able to:

- recognize 2D shapes and identify them in their surroundings
- use terms associated with shapes correctly
- identify straight and curved lines
- recognize vertical, horizontal, and oblique lines
- draw lines of a given length using a ruler

### Teaching materials:

- wooden or plastic letters and numerals
- rectangular sheets of coloured paper
- cut outs of various shapes
- a few lengths of rope
- a ruler

### Learning activity

#### Lesson 1: 2D figures

**40 minutes**

Children have seen many geometrical shapes (2D and 3D) since they were born. 2D shapes include the shapes of the ceiling, walls and windows, the rectangular rim of a cot, a table or picture frames, spheres (balls), sugar cubes, various cuboid boxes, the circle and the oval of the mother's eye, and the triangles of clothes' hangers. 3D objects include a milk bottle, the hand of the mother, dolls, the duck in the bath tub, a ball, and so many other objects. Children may not know the geometrical names, but they are indeed familiar with these shapes.

The concept of geometrical shapes and their properties is best introduced and explained with hands-on activities in the classroom. Show plastic or wooden letters of the alphabet and numerals from 0 to 9. These make excellent tools for introducing basic geometric concepts such as straight and curved lines, and closed and open shapes.

Talk about the letters of the alphabet and numerals written using only straight lines or only curved lines, or both straight and curved lines. They should write these in their exercise books, in a large, bold writing.

Then, they trace the letters and numerals with a pencil, starting from a point. If the pencil returns to the starting point without having to lift it, the letter is a closed shape. For example: letters such as O, and parts of A, B, D, and Q and numerals such as 8 and 0. Ask them to identify closed and open shapes in objects they see in the classroom or in real life. A clothes' hanger has a closed triangular shape and an open shaped hook. The rim of a glass or a bowl is a closed figure.

Then, with your help, each child folds a piece of papers to make a square, a triangle, a rectangle, and other familiar shapes.

The children enjoy making simple origami figures. Call out the names of the shapes as you make the folds, as you create the figure. They follow the steps and make simple origami shapes. (Very interesting books are available which show simple shapes.)

**Task:** Children attempt page 105.

## Lesson 2: 2D figures (continued)

**40 minutes**

Use cutouts of various triangles, squares, and rectangles. Let the children count and list the number of sides and corners (vertices).

<u>Shape</u>	<u>No. of sides</u>	<u>No. of vertices</u>
Square	4	4
Rectangle	4	4
Triangle	3	3

Ask them to find a pattern ... Are there ALWAYS as many sides as vertices?

Talk about a circle in this context: it is a single closed shape and has no vertices.

At this point, introduce the concepts of area and perimeter. To demonstrate the perimeter of a shape, ask the children to colour along the edges of any 2D shape. To demonstrate area, ask them to colour the surface of the shape. Explain or elicit that the edge of a windowpane is the perimeter and the glass pane is the surface.

Take the children into the playground for this activity. Ask them to work in groups of 5 and give each group a long piece of rope. Call out a shape, for example, a square. The children should make the shape using the rope as the sides and themselves as

the vertices. For example: for a square, 4 children hold the rope, and stretch it to make equal sides. The children standing at the 4 corners are the vertices and the lengths of the rope are the sides. A little guidance will be necessary to make right angles for a square. Otherwise, the shape will become a rhombus: a quadrilateral with equal sides.

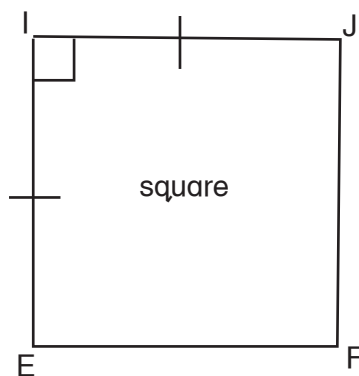
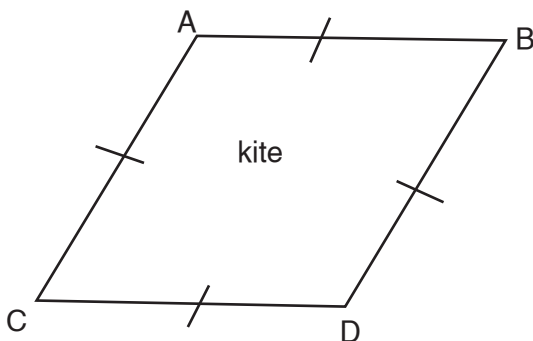

**Task:** Children attempt pages 107 and 108.

### Lesson 3: Lines and curves

**40 minutes**

Ask the children to stand in one corner of the playground and ask one of them to bring an object from the opposite end. Ask the children to observe the route he takes. Note that he does not go along the wall. Instead, he walks along the diagonal, which is the shortest route. Talk about the shortest route. Even a bird will fly from one tree to the other, across the garden, along the diagonal of the garden! Why? The diagonal is a shorter route than going along the sides. Measurement will prove this.

Draw lines of different lengths on the board using a long ruler. Talk about the uses of a ruler and how it is used to draw lines. By observing you, the children will learn to draw lines of specific lengths in their books.

Then, they draw lines of specified lengths, and measure lines drawn by other children to check for accuracy.

You could also give them a drawing assignment in which you specify the lengths of the line segments to be drawn.

**Task:** Children attempt pages 110 and 112.

#### Additional resources:

At the end of the guide are additional worksheets 15 and 16. Use them for reinforcement.

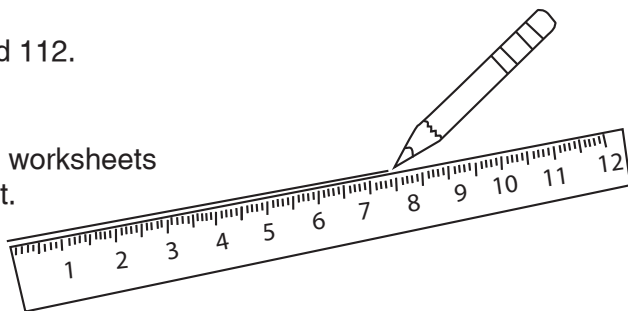

## UNIT 7

# REVIEW AND ASSESS 2

### Teaching objectives

- to revise the concepts learnt throughout the year
- to recap place value
- to revise ascending and descending orders
- to revise fractions
- to solve problems using the four operations i.e. addition, subtraction, multiplication, and division
- to revise measurement and capacity
- to tell the time using a.m. and p.m.
- to recap horizontal, vertical, straight, and curved lines

### Learning outcomes

The children should be able to:

- identify the place values in given numbers
- write numbers in ascending and descending orders
- demonstrate an understanding of fractions
- solve problems using the four operations i.e. addition, subtraction, multiplication, and division
- demonstrate an understanding of measurement and capacity
- tell the time using analogue and digital clocks
- identify horizontal, vertical, straight, and curved lines

### Teaching materials:

- additional worksheets

### Learning activity

#### Lesson 1

**40 minutes**

Revise place values. Give the class plenty of practice both oral and written. It is important to recap before attempting to assess the children's learning, as this revises concepts taught earlier in the year.

**Task:** Children attempt pages 114, 115, and 116.

## **Lesson 2**

**40 minutes**

Revise fractions. As this is a difficult concept for the children to grasp, it will be helpful to refer to the unit on fractions to revise the topic.

**Task:** Children attempt pages 117 and 118.

## **Lesson 3**

**40 minutes**

The most important concepts learnt in the early years are the four operations, i.e. addition, subtraction, multiplication, and division since they are the basis of all mathematics.

Give the children plenty of practice using the worksheets given. Refer to the explanations in the earlier units on addition, subtraction, multiplication, and division for further practice.

**Task:** Children attempt pages 119 to 123.

## **Lesson 4**

**40 minutes**

Revise the work done on time and on horizontal, vertical, oblique, curved, and straight lines.

**Task:** Children attempt pages 124 and 125.

### **Additional resources:**

At the end of the guide are additional worksheets 17 to 22. Use them for reinforcement.



# Worksheet 1

Fill in the missing numbers.

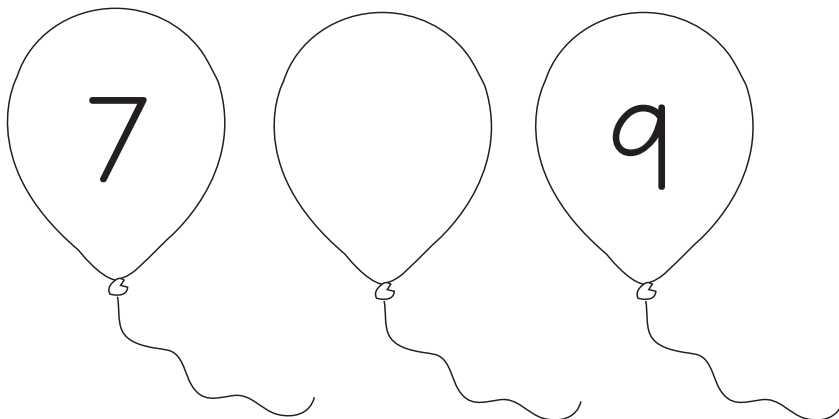
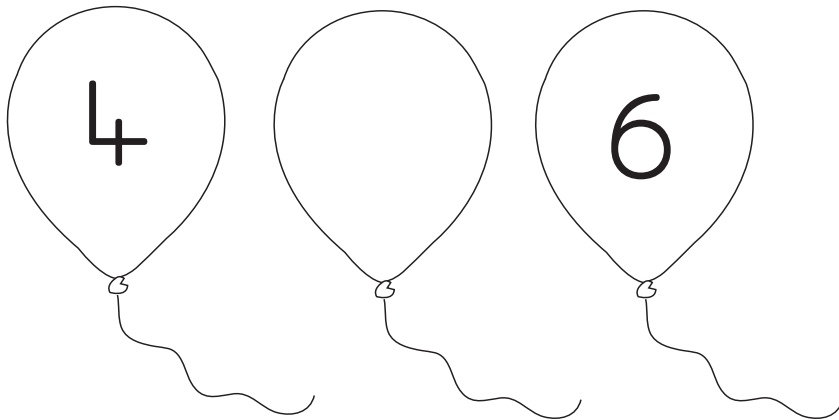
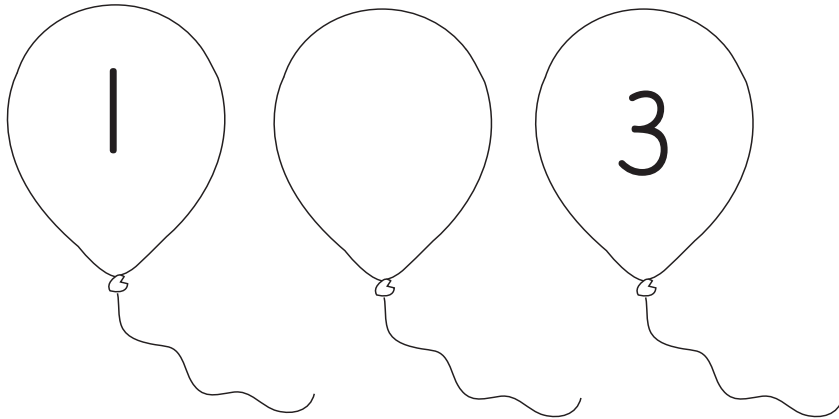

# Worksheet 2

Count the shapes.

□ Square \_\_\_\_\_

○ Circle \_\_\_\_\_

△ Triangle \_\_\_\_\_

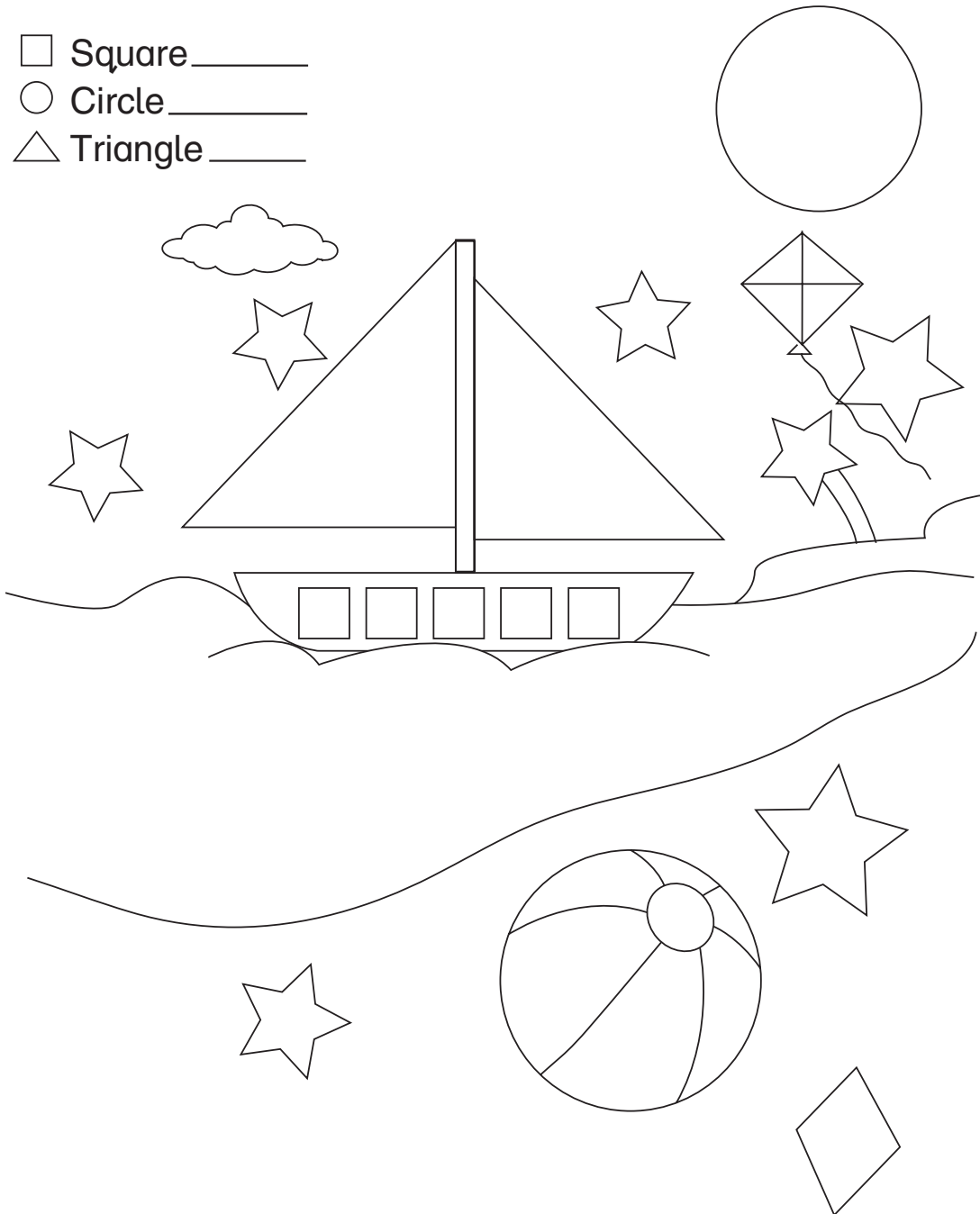

# Worksheet 3

Trace and match.

EIGHT

ONE

THREE

FOUR

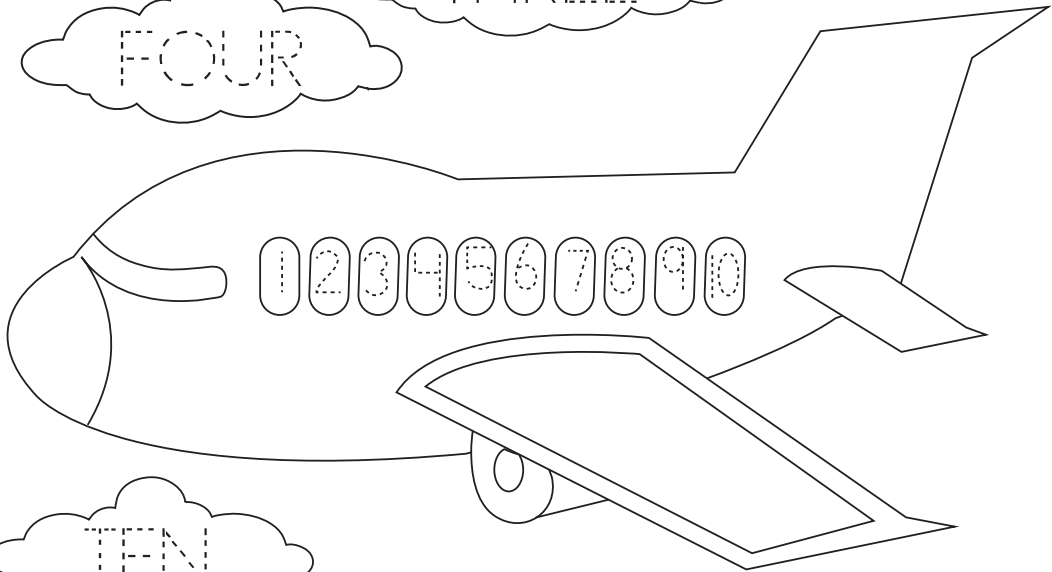

TEN

SIX

TWO

NINE

FIVE

SEVEN

# Worksheet 4

Fill in the missing numbers.

1

3

6

8

9

11

14

16

17

19

22

24

25

27

# Worksheet 5

Fill in the missing numbers.

1. Count from 4 to 13.



2. Count from 12 to 21.



3. Count from 25 to 34.



4. Count from 15 to 24.



5. Count from 35 to 44.



6. Count from 41 to 50.



# Worksheet 6

Place value.

$$\text{Twenty five} = 20 + \text{cloud}$$

$$\text{Thirty eight} = 30 + \text{cloud}$$

$$\text{Forty eight} = 40 + \text{cloud}$$

$$\text{Eighty six} = 80 + \text{cloud}$$

$$\text{Twenty nine} = 20 + \text{cloud}$$

$$\text{Fifty four} = 50 + \text{cloud}$$

# Worksheet 7

Write >, <, or = in the circles.

$5 \bigcirc 8$

$9 \bigcirc 7$

$1 \bigcirc 3$

$9 \bigcirc 3$

$8 \bigcirc 7$

$6 \bigcirc 6$

$5 \bigcirc 9$

$9 \bigcirc 9$

$3 \bigcirc 2$

$9 \bigcirc 8$

$8 \bigcirc 4$

$5 \bigcirc 6$

$9 \bigcirc 4$

$7 \bigcirc 5$

$7 \bigcirc 3$

$8 \bigcirc 6$

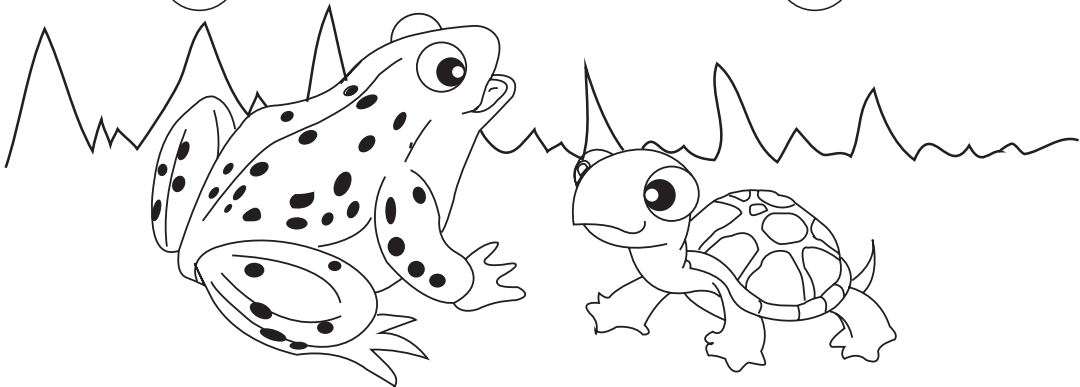

# Worksheet 8

Colour the following figures according to the fraction written against each.

$\frac{8}{8}$

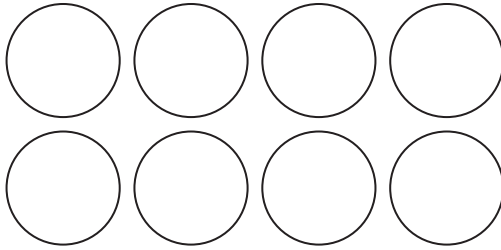

$\frac{4}{10}$



$\frac{3}{4}$

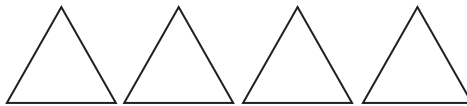

$\frac{7}{8}$

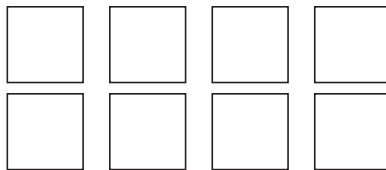



# Worksheet 9

Trace and colour the given fraction.

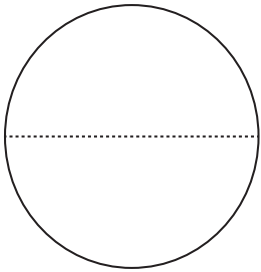

$\frac{1}{2}$

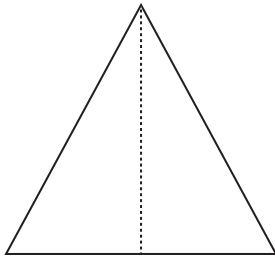

$\frac{1}{2}$

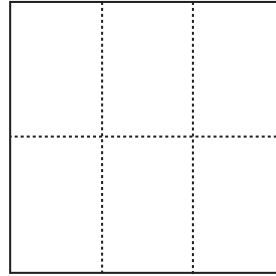

$\frac{1}{2}$

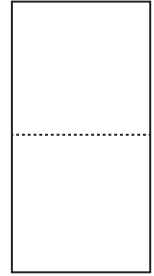

$\frac{1}{2}$

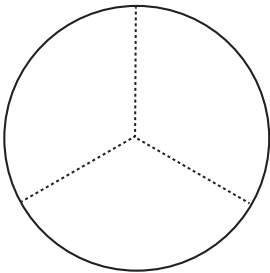

$\frac{1}{3}$

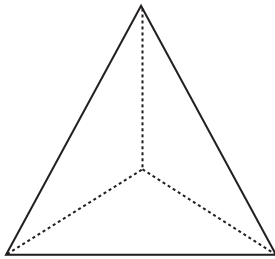

$\frac{1}{3}$

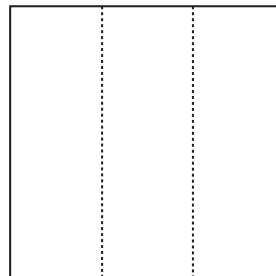

$\frac{1}{3}$

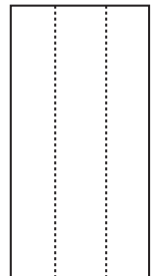

$\frac{1}{3}$

# Worksheet 10

Count and write the correct number.

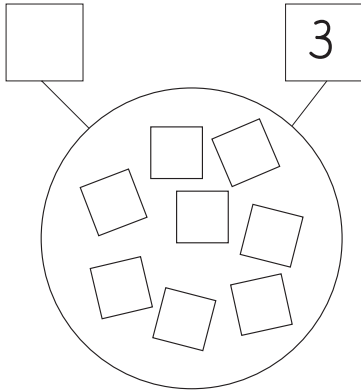

$$\text{---} + 3 = 8$$

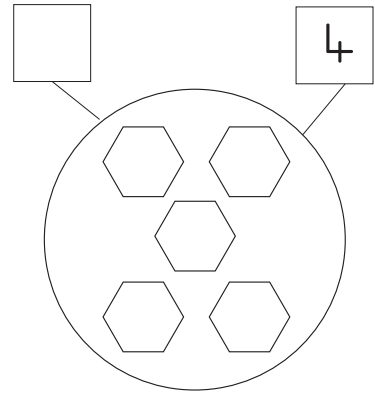

$$\text{---} + 4 = 5$$

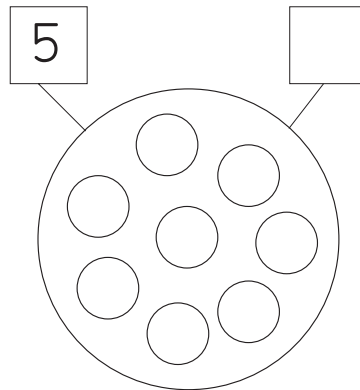

$$5 + \text{---} = 8$$

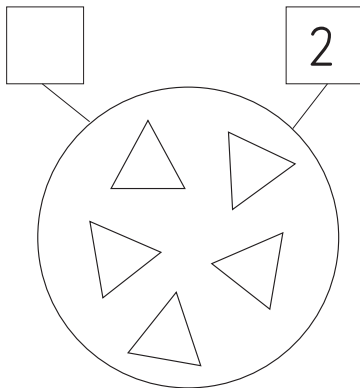

$$\text{---} + 2 = 5$$

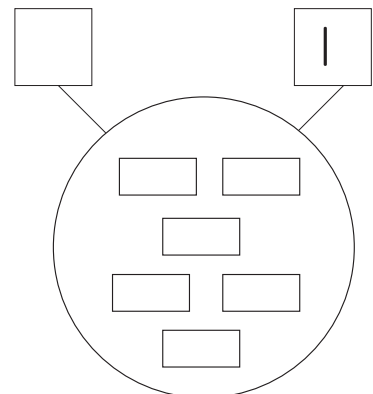

$$5 + 1 = \text{---}$$

# Worksheet 11

Write the answers in the given space.

$$6 \div 2 = \underline{\quad}$$



$$2 \times \underline{\quad} = 12$$

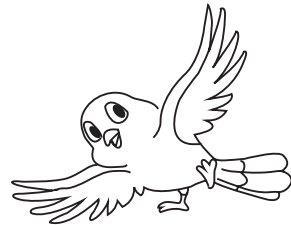

$$20 \div 5 = \underline{\quad}$$

$$5 \times \underline{\quad} = 20$$



$$30 \div 5 = \underline{\quad}$$

$$5 \times \underline{\quad} = 30$$

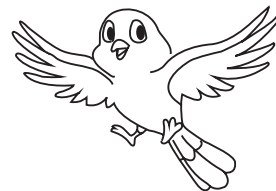

# Worksheet 12

Will you use 'm' or 'cm' to measure:

Length of a door \_\_\_\_\_

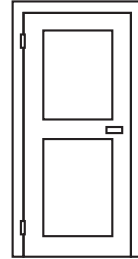

Length of a pencil \_\_\_\_\_

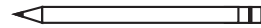

Length of a car \_\_\_\_\_

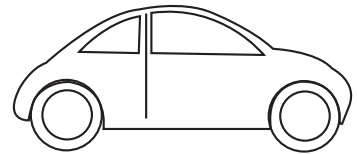

Height of a flamingo \_\_\_\_\_

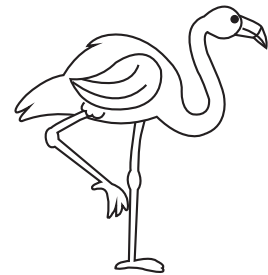

Length of a whale \_\_\_\_\_

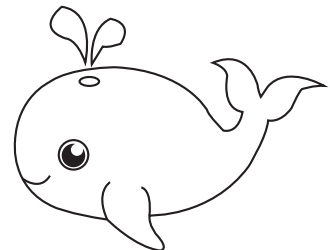

# Worksheet 13

In each pair tick (✓) the object with the greater capacity.

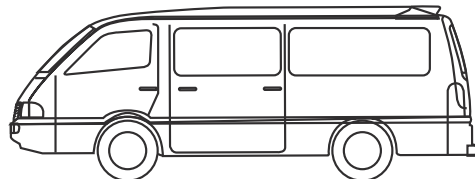
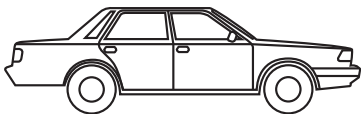
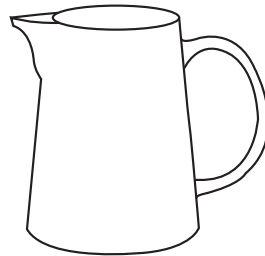
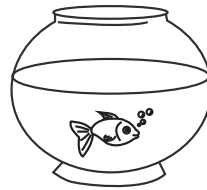
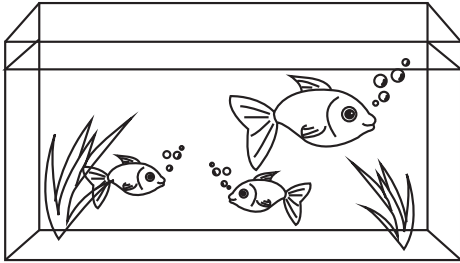

# Worksheet 14

Draw hands on each clock to show the given time.

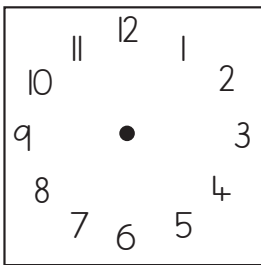

Half past 4

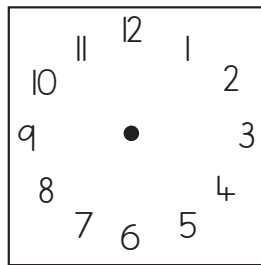

2 o' clock

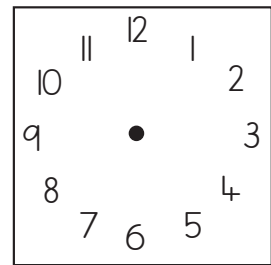

quarter to 9

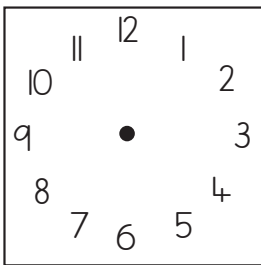

quarter to 6

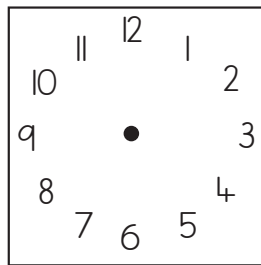

quarter past 3

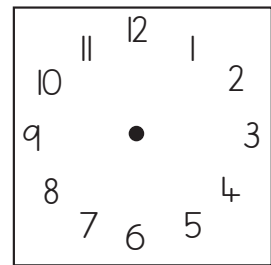

half past 7

# Worksheet 15

Match the shape to its name.

diamond

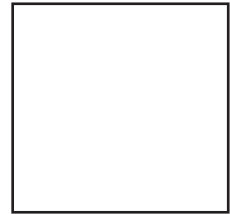

triangle

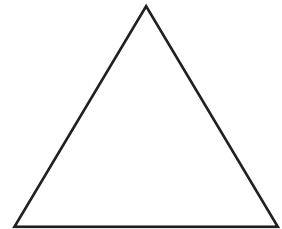

circle

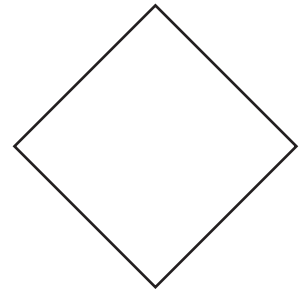

square

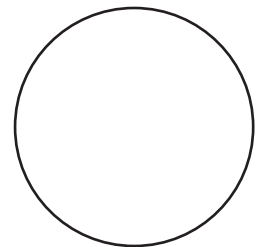

# Worksheet 16

In each group circle the object(s) you would use to draw the shape on the left.

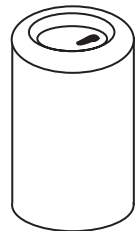
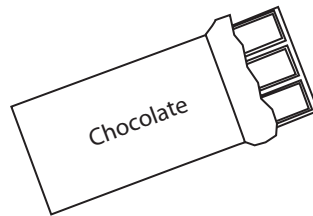
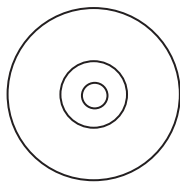
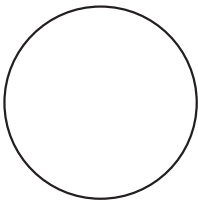
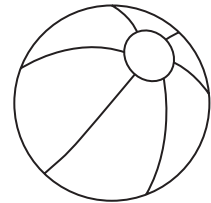
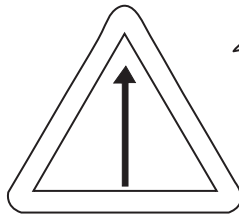
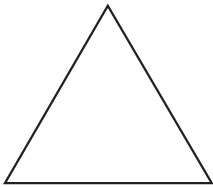
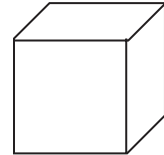
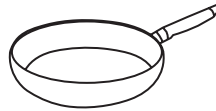
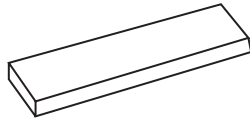



# Worksheet 17

Write > or < in the circle.

$6 \bigcirc 11$

$4 \bigcirc 5$

$8 \bigcirc 3$

$9 \bigcirc 8$

$1 \bigcirc 4$

$6 \bigcirc 0$

$9 \bigcirc 23$

$10 \bigcirc 11$

$3 \bigcirc 7$

$9 \bigcirc 6$

$0 \bigcirc 6$

$10 \bigcirc 5$

$5 \bigcirc 8$

$4 \bigcirc 3$

$3 \bigcirc 5$

$9 \bigcirc 11$

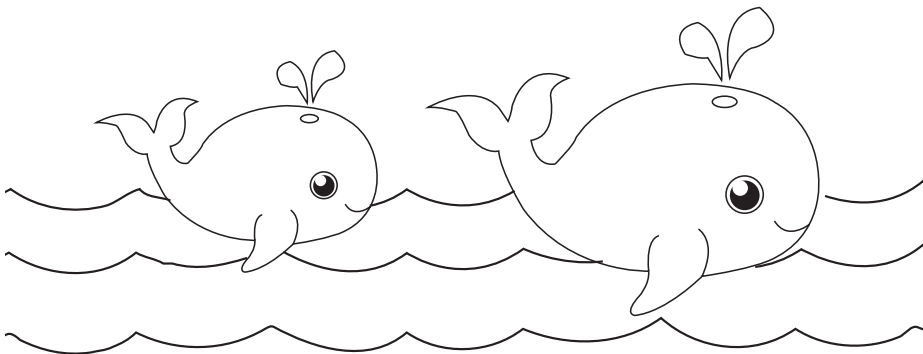

# Worksheet 18

Trace the shapes and write their names.

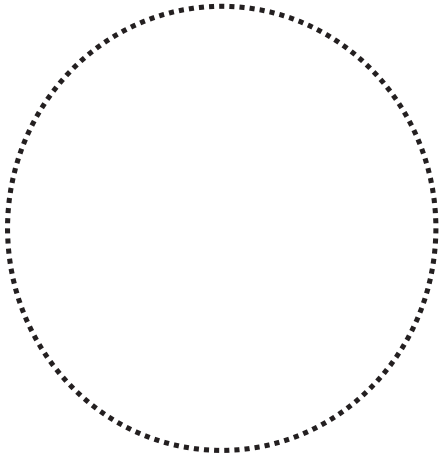

---

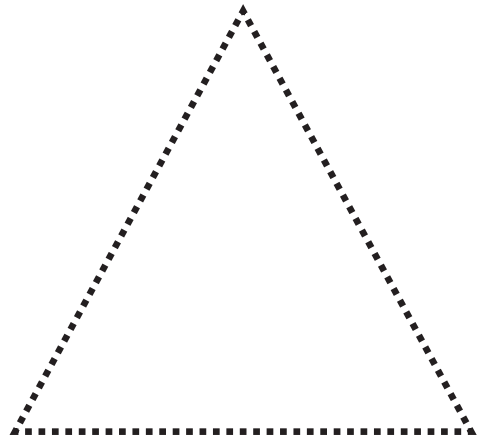

---



---

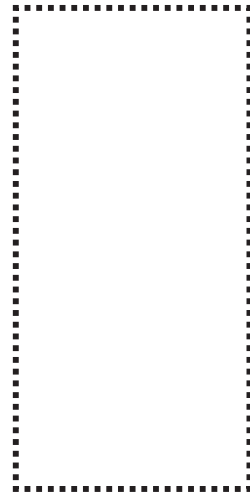

---

# Worksheet 19

Write  $<$ ,  $>$ , or  $=$  in the circles.

$11 \bigcirc 4$

$4 \bigcirc 6$

$3 \bigcirc 9$

$8 \bigcirc 8$

$4 \bigcirc 6$

$0 \bigcirc 1$

$23 \bigcirc 10$

$11 \bigcirc 9$

$7 \bigcirc 9$

$6 \bigcirc 3$

$6 \bigcirc 10$

$5 \bigcirc 0$

$8 \bigcirc 4$

$3 \bigcirc 5$

$5 \bigcirc 9$

$11 \bigcirc 3$

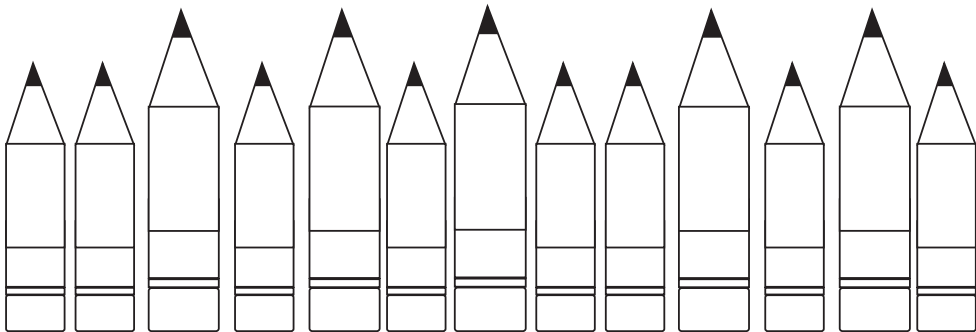

# Worksheet 20

## Ascending and descending order.

Write in ascending order.

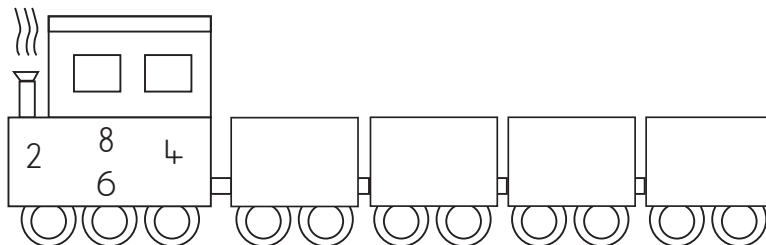
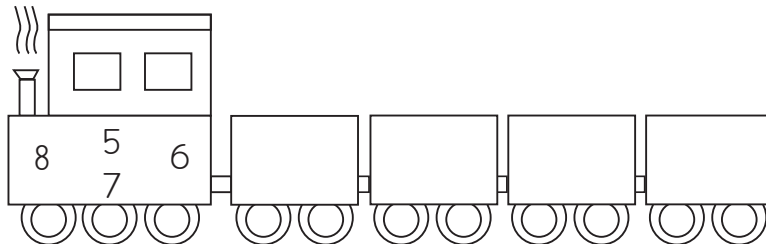

Write in descending order.

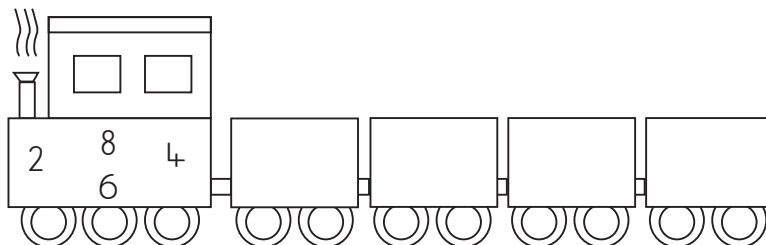
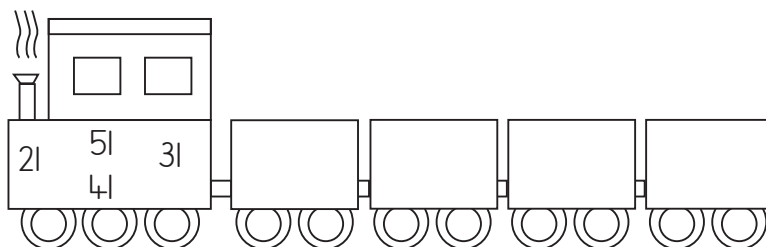

# Worksheet 21

Colour the star with the given number name.

Nineteen



Eighty-eight



Seventy-eight



Seventy-six



Fifty-four



Twenty-four



## Worksheet 22

Write the answers in the box.

$3 \times 4 = \square$

$6 \div 2 = \square$

$9 \times 6 = \square$

$9 \div 3 = \square$

$10 \times 4 = \square$

$15 \div 5 = \square$

$4 \times 6 = \square$

$10 \div 5 = \square$

$9 \times 5 = \square$

$16 \div 4 = \square$

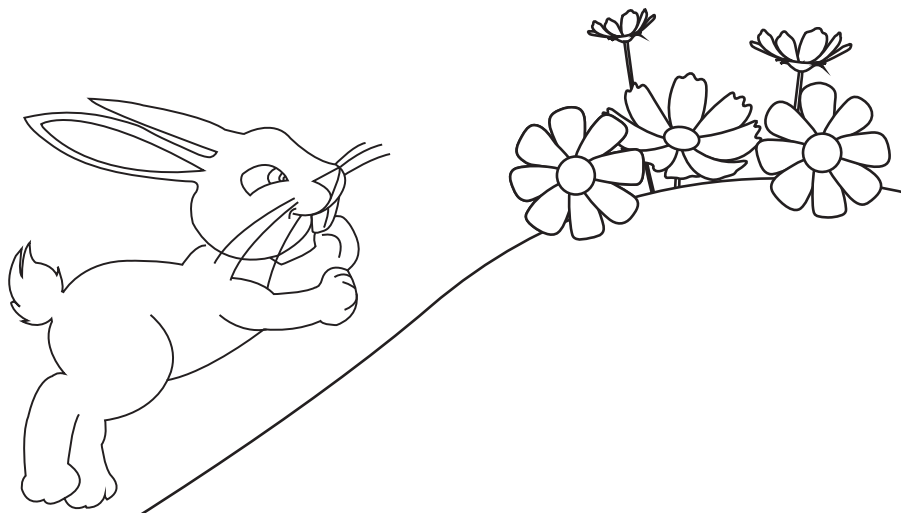

## Answers to Unit 1

### Page 2

Missing numbers: 3, 4, 5, 8, 9, 10, 12, 14, 15, 17, 18, 20

### Page 3

Less, more, less, less, more, less, less

### Page 4

9, nine; 8, eight; 7, seven; 6, six; 5, five; 4, four; 3, three; 2, two; 1, one

### Page 5

Ladder 1: 17, 18, 19, 20, 21, 22, 23

Ladder 2: 91, 92, 93, 94, 95, 96, 97

Ladder 3: 28, 29, 30, 31, 32, 33, 34

Ladder 4: 44, 45, 46, 47, 48, 49, 50

### Page 6

Snake 1: 77, 78, 79, 80, 83, 84, 85, 86, 87, 88, 89, 90, 91

Snake 2: 3, 4, 6, 7, 8, 10, 11, 12, 14, 15, 17, 18, 19

Snake 3: 89, 87, 86, 84, 83, 81, 80, 78, 77, 76,

Snake 4: 53, 52, 51, 50, 49, 47, 45, 44, 43, 42, 41, 39

### Page 7

33, 67, 6, 11

## Answers to Unit 2

### Page 15

1st group of hens: 10

2nd group of hens: 10 and 8

Total number of hens on the page: 28

### Page 17

#### Exercise 1

2.  $600 + 90 + 2 = 692$

3. 8 hundreds + 7 tens + 5 ones =  $800 + 70 + 5 = 875$

4.  $600 + 90 + 0 = 690$

5.  $300 + 30 + 3 = 333$

### Exercise 2

Numbers to circle: 2. 29      3. 876      4. 310, 20      5. 67, 960

### Exercise 3

2. 898, 899, 900, 901, 902

1. 319, 320, 321, 322, 323

2. 457, 458, 459, 460, 461

3. 898, 899, 900, 901, 902

### Exercise 4

2. seven hundred and sixty-five

3. nine hundred and nine

4. two hundred and sixty-five

5. eight hundred and ninety-seven

### Exercise 5

2. 213

3. 768

4. 502

5. 969

6. 666

### Exercise 6

2. 300 40 5

3. 700 60 4

4. 900 40 5

### Exercise 7

2. 382

3. 741

4. 830

### Exercise 8

2. 385

3. 863

4. 318

### Exercise 9

2. 901

3. 317

4. 230

5. 657

### Exercise 10

1. 399

2. 449

3. 589

4. 989



### **Exercise 11**

2. 486, 476, 466, 456, 446
3. 668, 658, 648, 638, 628
4. 254, 244, 234, 224, 214

### **Exercise 12**

2. 557, 657, 757, 857, 957
3. 265, 365, 465, 565, 665
4. 612, 712, 812, 912, 1012

### **Exercise 13**

2. Tick 788, cross 234
3. Tick 987, cross 124
4. Tick 907, cross 283

### **Exercise 14**

2. descending
3. descending
4. descending
5. ascending

### **Exercise 15**

1. 454, 456, 465, 654
2. 567, 575, 765, 866
3. 567, 686, 786, 875
4. 98, 346, 908, 987
5. 153, 466, 541, 764

### **Exercise 16**

1. 432, 423, 242, 124
2. 764, 574, 475, 354
3. 977, 800, 796, 658
4. 932, 439, 293, 202
5. 908, 891, 890, 809

### **Exercise 17**

1. 496, 558
2. 579, 778
3. 800, 907

4. 649, 748
5. 799, 495
6. 100, 190

#### Exercise 18

2. TRUE
3. TRUE
4. TRUE
5. FALSE
6. FALSE

#### Exercise 19

2. 44 is greater than 29.
3. 67 is greater than 54.
4. 98 is greater than 35.
5. 69 is greater than 78.
6. 99 is greater than 78.

#### Exercise 20

1. <      2. >      3. >
4. <      5. <      6. >

#### Exercise 21

Each illustration is divided into halves by drawing a vertical line across the middle.

#### Exercise 22

1.

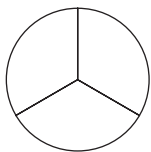

2.

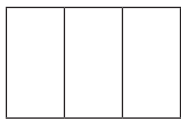

3.

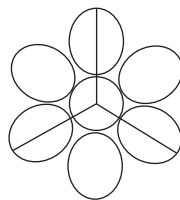

Each illustration is divided into thirds by drawing lines as shown:

#### Exercise 23

1.  $\frac{3}{6}$
2.  $\frac{2}{5}$
3.  $\frac{5}{8}$
4.  $\frac{9}{15}$

### Exercise 24

1.  $\frac{6}{8}$       2.  $\frac{4}{6}$       3.  $\frac{5}{10}$       4.  $\frac{3}{7}$

### Exercise 25

Colour according to the fraction given.

### Exercise 26

- 1st row:                      The circle and the rectangle are equally divided.  
2nd row:                      The square is equally divided.

### Exercise 27

1.  $\frac{1}{3}$       2.  $\frac{1}{4}$       3.  $\frac{1}{2}$

### Exercise 28

1.  $\frac{1}{2}, 2$       2.  $\frac{1}{4}, 4$       3.  $\frac{1}{4}, 2$

### Exercise 29

1. Tick  $\frac{2}{8}$       2. Tick  $\frac{2}{6}$       3. Tick  $\frac{6}{7}$   
4. Tick  $\frac{8}{8}$       5. Tick  $\frac{5}{10}$       6. Tick  $\frac{6}{10}$

## Answers to Unit 3

### Exercise 1

1. 10      2. 10      3. 10      4. 13  
5. 15      6. 12      7. 10      8. 16

### Exercise 2

1. 78      2. 52      3. 91      4. 47  
5. 52      6. 65      7. 74      8. 28  
9. 51      10. 32

### Exercise 3

1. 84      2. 73      3. 81      4. 84  
5. 77      6. 97      7. 79      8. 99

**Exercise 4**

1. Rs 90    2. 85 books    3. Rs 90    4. 30 bananas

**Exercise 5**

1. 649    2. 938    3. 699    4. 889

**Exercise 6**

1. 578 stamps    2. 795 books    3. Rs 995    4. 788 pages

**Exercise 7**

1. 594    2. 362    3. 1190    4. 830  
5. 493    6. 439    7. 604    8. 1005

**Exercise 8**

1. 420    2. 607    3. 598    4. 690  
5. 923    6. 836

**Exercise 9**

1. 237    2. 700    3. 1045    4. 525    5. 1042

**Exercise 10**

1. 17    2. 18    3. 49    4. 54  
5. 14    6. 27    7. 15    8. 37  
9. 19    10. 32

**Exercise 11**

Circle:

1. 48, 30    2. 94, 76    3. 45, 27  
4. 47, 10    5. 84, 47    6. 55, 18

**Exercise 12**

2. 15 monthly magazines    3. Rs 13    4. Rs 77  
5. Rs 16

**Exercise 13**

1. 111    2. 211    3. 212    4. 210  
5. Rs 112    6a. 110    6b. 135

**Exercise 14**

1. 169    2. 371    3. 3    4. 356  
5. 328    6. 284    7. 132    8. 170

### Exercise 15

- 150 pages
- 1029 km
- Rs 900
- 130 people
- Rs 100

## Answers to Unit 4

### Exercise 1

- m
- cm
- m
- m
- cm
- cm

### Exercise 2

nail file: 10 cm, pencil: 6 cm, key: 5 cm, screw: 6 cm

### Exercise 3

- Monty
- Shelly
- Monty
- Shelly
- Torty

### Exercise 4

Children draw lines of the given lengths.

### Exercise 5

- 177 cm
- 134 cm
- 20 cm
- 17 cm

### Exercise 6

The answers would vary for this except for the Maths Wise Book 2.

### Exercise 7

- 100 g
- 1 g
- 800 g
- 3 g
- 1 g
- 300 g

### Exercise 8

- 1a. 898 g
- 1b. 798 g
2. 655 g
3. 370 g
4. 2175 g
6. maximum weight peaches, minimum weight baked beans, 695 g

### Exercise 9

- > than 1 l
- < than 1 l
- > than 1 l
- > than 1 l
- < than 1 l

### Exercise 10

Children circle the following;

- watering can
- jug
- cup
- fish bowl

### Exercise 11

5 ml, 250 ml, 3 l, 1 l, 20 l

### Exercise 12

1. 90 ml, 365 ml, 680 ml, 2 l
2. 125 l
3. 600 ml
4. 225 ml
5. 825 ml

### Exercise 16

- |       |        |      |      |
|-------|--------|------|------|
| 1. 10 | 2. 2   | 3. 1 | 4. 0 |
| 5. 20 | 6. 4   | 7. 0 | 8. 2 |
| 9. 5  | 10. 21 |      |      |

### Exercise 17

- |      |       |      |      |
|------|-------|------|------|
| 1. > | 2. <  | 3. = | 4. < |
| 5. < | 6. <  | 7. < | 8. > |
| 9. < | 10. < |      |      |

### Exercise 18

- |       |       |       |       |
|-------|-------|-------|-------|
| 1. 28 | 2. 24 | 3. 27 | 4. 30 |
| 5. 16 | 6. 36 | 7. 10 | 8. 80 |

### Exercise 19

- |                 |             |                |          |
|-----------------|-------------|----------------|----------|
| 1. 6 flowers    | 2. 36 km    | 3. 40 coconuts | 4. Rs 45 |
| 5a. 14 balloons | 5b. Rs 10   | 5c. Rs 70      | 6. Rs 20 |
| 7. 15 saplings  | 8. 25 hours |                |          |

### Exercise 20

- |              |            |              |                |
|--------------|------------|--------------|----------------|
| 1. 2 flowers | 2. 5 fish  | 3. 3 pieces  | 4. 3 kites     |
| 5. 5 nuts    | 6. 2 cones | 7. 5 bananas | 8. 9 sailboats |

### Exercise 21

- |         |         |         |         |
|---------|---------|---------|---------|
| 1. 3, 3 | 2. 5, 5 | 3. 5, 5 | 4. 5, 5 |
| 5. 4, 4 | 6. 4, 4 |         |         |

### Exercise 22

- |                      |                      |                       |                      |
|----------------------|----------------------|-----------------------|----------------------|
| 2. $2 \times 7 = 14$ | 3. $3 \times 6 = 18$ | 4. $2 \times 10 = 20$ | 5. $4 \times 7 = 28$ |
| $7 \times 2 = 14$    | $6 \times 3 = 18$    | $10 \times 2 = 20$    | $7 \times 4 = 28$    |

$14 \div 7 = 2$

$18 \div 3 = 6$

$20 \div 2 = 10$

$28 \div 7 = 4$

$14 \div 2 = 7$

$18 \div 6 = 3$

$20 \div 10 = 2$

$28 \div 4 = 7$

### Exercise 23

1. 6      2. 6      3. 7      4. 9  
5. 9      6. 9      7. 9      8. 10

### Exercise 24

- 1a. 4      1b. 6      2a. 7      2b. 4  
3a. 9      3b. 7      4a. 6      4b. 9

### Exercise 25

1. Rs 1512a. 385 cans      2b. 515 cans      3. Rs 10  
4. Rs 75 5a. Rs 3035b. Rs 3306.      Rs 40

## Answers to Unit 5

### Exercise 1

1. 9:00, 9 o'clock      2. 6:00, 6 o'clock  
3. 4:00, 4 o'clock      4. 11:30, half past 11  
5. 5:45, quarter to 6      6. 2:15, quarter past 2

## Exercise 2

1.



2.



3.



4.

5.

6.

## Exercise 3

- |                          |                              |
|--------------------------|------------------------------|
| 1. 3:40, three forty     | 2. 11:25, eleven twenty-five |
| 3. 4:55, four fifty-five | 4. 7:20, seven twenty        |
| 5. 2:50, two fifty       | 6. 8:10, eight ten           |
| 7. 4:15, four fifteen    | 8. 7:45, seven forty-five    |

## Exercise 4

Show joined clocks and times here.



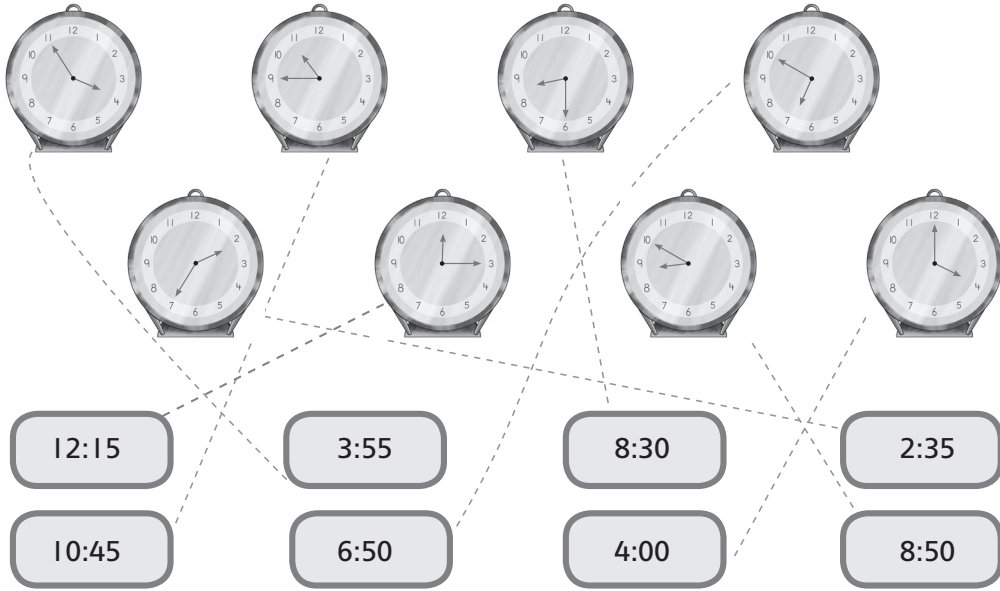

### Exercise 5

(√) 15 minutes, (√) 3 minutes, (√) 8 hours,  
 (√) 7 days, (√) 1 minute, (√) 2 hours

### Exercise 6

- |         |         |         |
|---------|---------|---------|
| 1. a.m. | 2. p.m. | 3. a.m. |
| 4. p.m. | 5. p.m. |         |

- |           |           |          |
|-----------|-----------|----------|
| 1. before | 2. after  | 3. after |
| 4. before | 5. before |          |

- |          |           |           |
|----------|-----------|-----------|
| 1. after | 2. after  | 3. before |
| 4. after | 5. before |           |

- |             |             |          |
|-------------|-------------|----------|
| 1. daylight | 2. daylight | 3. night |
| 4. daylight | 5. night    |          |

- |         |         |         |
|---------|---------|---------|
| 1. a.m. | 2. p.m. | 3. both |
| 4. a.m. | 5. p.m. | 6. p.m. |

### Exercise 7

1. February
2. 2
3. 29 days (February normally has 28 days, but it has 29 days in a leap year as explained in Book 3.)

### Exercise 8

- |            |             |
|------------|-------------|
| 1a. Sunday | 1b. Tuesday |
| 2a. 18     | 2b. 26      |

### Exercise 9

- |              |            |                      |  |
|--------------|------------|----------------------|--|
| 1a. Saturday | 1b. Monday |                      |  |
| 2. Tuesday   | 3. 17th    | 4. 31, 3, 10, 17, 24 |  |

### Exercise 10

Children make a list of public holidays for the current year.

- |              |            |
|--------------|------------|
| 7. 28 people | 8. 11 cars |
|--------------|------------|

## Answers to Unit 6

### Exercise 1

- |   |              |
|---|--------------|
| 1. circle                                 | 2. rectangle |
| 3. circles on the base and top of the can | 4. square    |

### Exercise 2

4 squares, 4 triangles

### Exercise 3

circle the chocolate bar, circle the road sign, circle the floppy disk

### Exercise 4

Children draw the figures exactly as given and then colour the lines as stated. Guide them, checking their work.

The straight line, XY, is the shortest.

### Exercise 5

Children measure all routes and find that the straight line is the shortest.

### Exercise 6

Check that the children draw exact measures.

### Exercise 7

H = Horizontal

V = Vertical

O = Oblique

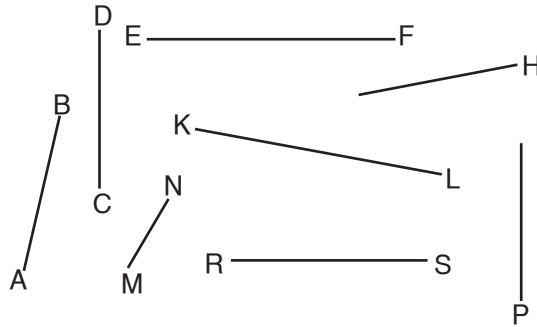

## Answers to Unit 7

### Exercise 1

33 pies

### Exercise 2

1. HTO
2. HTO
3. HTO
4. HTO
5. HTO

### Exercise 3

1. 299
2. 698
3. 208
4. 325
5. 850
6. 610

### Exercise 4

1-digit numbers: 9, 7

2-digit numbers: 32, 56, 99, 29, 88

3-digit numbers: 820, 370, 299, 750, 999

### Exercise 5

1. 140, 144
2. 322, 324
3. 260, 261
4. 900, 901, 903, 904

### Exercise 6

1. 98, 190, 214, 790
2. 93, 100, 129, 895
3. 156, 175, 492, 612
4. 111, 222, 555, 777

### Exercise 7

1. 499, 490, 451, 419, 49
2. 957, 819, 387, 297, 197
3. 876, 867, 675, 655, 568
4. 901, 832, 671, 444, 211

### Exercise 8

1. 726
2. 873
3. 168

### Exercise 9

1.  $\frac{4}{8}$
2.  $\frac{3}{6}$
3.  $\frac{2}{4}$

### Exercise 10

#### Circle: 4 buttons

$\frac{1}{4}$  of 8 is 2 buttons

2. buttons

$\frac{1}{5}$  of 15 is 3 buttons

### Exercise 11

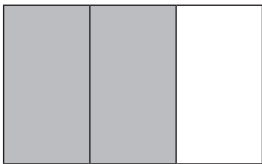
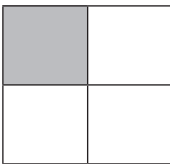
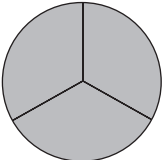
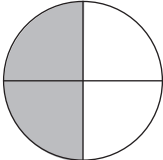
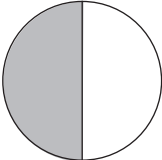
1. 
2. 
3. 
4. 
5. 
6. 

### Exercise 12

1. 28    2. 67    3. 28    4. 48  
5. 61    6. 90    7. 72    8. 101  
9. 99    10. 66    11. 28    12. 78  
13. 87    14. 32    15. 46    16. 8  
17. 28    18. 5    19. 70    20. 79

### Exercise 13

1. Rs 115    2. 49 cars    3. 18 cups    4. 24 items  
5. 13 fish    6. 59 cards    7. 16 trees    8. 24 points

### Exercise 14

1. 6    2. 28    3. 10    4. 40  
5. 44    6. 30    7. 48    8. 50  
9. 55    10. 110

### Exercise 15

1. 32 legs    2. 25 hours    3. 24 runs

### Exercise 16

1. 9    2. 51    3. 10    4. 23  
5. 18    6. 20

### Exercise 17

1. 2    2. 9 beads    3. 10 taxis, with 5 people left

### Exercise 18

1. 16 cms    2. 19 metres 14 cms  
3. 20 kg    4. 105 kg

### Exercise 19

1. 2 cups    2. 4 cups    3. bottle    4. yes  
5. No

### Exercise 20

spoon is 1, ink bottle is 2, cup is 3, glass is 4, vase is 5, fish bowl is 6, bucket is 7, swimming pool is 8

## Exercise 21

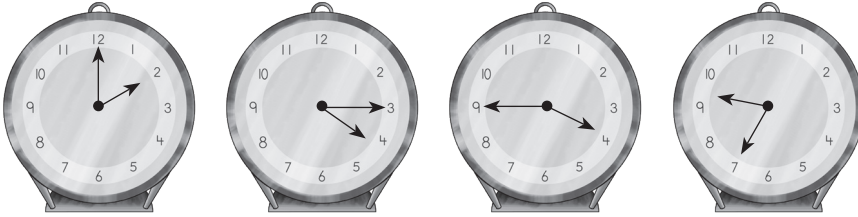

## Exercise 22

1. p.m.
2. p.m.
3. a.m.
4. a.m.
5. a.m.

## Exercise 23

1. A square with 'H' at the top, 'V' on the left, 'H' at the bottom, and 'V' on the right.
2. A horizontal rectangle with 'H' at the top, 'V' on the left, 'H' at the bottom, and 'V' on the right.
3. An equilateral triangle with 'O' at the top-left and top-right vertices, and 'H' at the bottom vertex.
4. A circle with the text 'C = curved' below it.

## Exercise 24

1. A photograph of a white arched bridge over water. Two arrows point to the bridge's structure: one to the horizontal base and one to the curved arch. Below the image is the text 'horizontal line curved line'.
2. A photograph of a sea and sky horizon. An arrow points to the horizontal line where the sea meets the sky. Below the image is the text 'horizontal line'.

3.



curved line

4.

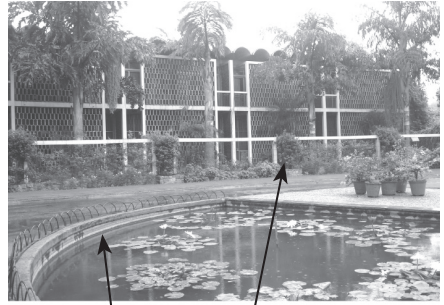

curved line straight lines

5.



vertical lines

6.



straight lines curved lines